

PROJECT



**PRICE LIST
2024**



EFFECTIVE APRIL 2024

Contents

—optipro—	MINIATURE CIRCUIT BREAKER (MCBs)	01 - 04
—optipro—	AC CIRCUIT BREAKER	05
—optipro—	DC CIRCUIT BREAKER	05 - 06
—optipro—	DC MCB WITH EXTENDED LINK AS PER RDSO	06
—optipro—	ISOLATOR	07
—optipro—	RESIDUAL CURRENT CIRCUIT BREAKER (RCCBs)	07
—optipro—	RCD ADD ON BLOCK	08
—optipro—	ACCESSORIES	08
—optipro—	DISTRIBUTION BOARDS (DBs)	09 - 15
	BUSBAR CHAMBER	16
	TIME SWITCHES	17
	TIMELITE DISTRIBUTION BOARDS	18
	AUTOMATIC CHANGEOVER	18
—optium—	MCCB - 1.0 (FIXED TM RANGE)	19 - 21
—optium—	MCCB - 2.0 (ADJUSTABLE TM RANGE)	21 - 23
—optium—	MCCB - 2.1 (ELECTRONIC RANGE)	23
—optium—	MCCB - 2.2 (ELECTRONIC RANGE WITH GROUND FAULT SETTING)	23 - 24
—optium—	MCCB - ACCESSORIES	24 - 26
—optipro—	SMDB	27 - 30
NEW	—optinova— SWITCH DISCONNECTOR / TSE (ONLOAD CHANGEOVER)	31 - 34
	HRC FUSE LINKS & BASES	35
	SWITCH DISCONNECTOR FUSES	36
	Ambidex CHANGEOVER SWITCHES	37
	REWIRABLE SWITCH FUSE UNITS	38
	Shynora WIRING ACCESSORIES	39 - 49
	Glint [™] WIRING ACCESSORIES	50 - 56
	ELVIRA WIRING ACCESSORIES	57 - 62
	Zosta [™] EXHAUST FAN	63 - 64
	INDOASIAN PLUGS	64
	FANCY BATTEN BULB HOLDER / CEILING ROSE	64 - 65



— optipro[™] —

RCCB & MCB

ALL THAT YOU NEED

Engineered to perfection with wide range and unmatched quality.

Contact Indication Window-
Visual indication ensure
safety of end user

**Low Power
Loss**



—optipro— **MINIATURE CIRCUIT BREAKER - MCB**

- ISI / CE Marked as per IS/IEC 60898 - 1 • Rated Short-Circuit Breaking Capacity, Icn 10kA • Degree of Protection IP 20
- Energy Limitation Class 3 • Line Load Reversibility • 35 sq. mm Terminals • Biconnect Terminals • Frequency: 50 Hz
- Operating Voltage : 240V/415V AC , 60V DC per pole

B CURVE SINGLE POLE

HSN Code: 8536

	Rating (A)	Pack	Cat. Nos.	Unit Price (₹)
	6	1/12/180	811008	265
10	1/12/180	811010	265	
16	1/12/180	811012	265	
20	1/12/180	811013	265	
25	1/12/180	811014	265	
32	1/12/180	811015	265	
40	1/12/180	811016	597	
50	1/12/180	811017	695	
63	1/12/180	811018	695	

B CURVE SINGLE POLE NEUTRAL

HSN Code: 8536

	Rating (A)	Pack	Cat. Nos.	Unit Price (₹)
	6	1/6/90	811027	892
10	1/6/90	811029	892	
16	1/6/90	811031	892	
20	1/6/90	811032	892	
25	1/6/90	811033	892	
32	1/6/90	811034	892	
40	1/6/90	811035	1248	
50	1/6/90	811036	1415	
63	1/6/90	811037	1415	

B CURVE DOUBLE POLE

HSN Code: 8536

	Rating (A)	Pack	Cat. Nos.	Unit Price (₹)
	6	1/6/90	811046	926
10	1/6/90	811048	926	
16	1/6/90	811050	926	
20	1/6/90	811051	926	
25	1/6/90	811052	926	
32	1/6/90	811053	926	
40	1/6/90	811054	1334	
50	1/6/90	811055	1487	
63	1/6/90	811056	1487	

C CURVE SINGLE POLE

HSN Code: 8536

	Rating (A)	Pack	Cat. Nos.	Unit Price (₹)
	0.5	1/12/180	811114	468
1	1/12/180	811115	468	
2	1/12/180	811117	468	
3	1/12/180	811119	468	
4	1/12/180	811120	468	
5	1/12/180	811121	468	
6	1/12/180	811122	278	
10	1/12/180	811124	278	
16	1/12/180	811126	278	
20	1/12/180	811127	278	
25	1/12/180	811128	278	
32	1/12/180	811129	278	
40	1/12/180	811130	562	
50	1/12/180	811131	670	
63	1/12/180	811132	670	

—optipro™— **MINIATURE CIRCUIT BREAKER - MCB**

C CURVE SINGLE POLE NEUTRAL

HSN Code: 8536

	Rating (A)	Pack	Cat. Nos.	Unit Price (₹)
	0.5	1/6/90	811136	978
	1	1/6/90	811137	978
	2	1/6/90	811139	978
	3	1/6/90	811141	978
	4	1/6/90	811142	978
	5	1/6/90	811143	978
	6	1/6/90	811144	918
	10	1/6/90	811146	918
	16	1/6/90	811148	918
	20	1/6/90	811149	918
	25	1/6/90	811150	918
	32	1/6/90	811151	918
	40	1/6/90	811152	1298
	50	1/6/90	811153	1462
	63	1/6/90	811154	1462

C CURVE DOUBLE POLE

HSN Code: 8536

	Rating (A)	Pack	Cat. Nos.	Unit Price (₹)
	0.5	1/6/90	811158	1120
	1	1/6/90	811159	1120
	2	1/6/90	811161	1120
	3	1/6/90	811163	1120
	4	1/6/90	811164	1120
	5	1/6/90	811165	1120
	6	1/6/90	811166	944
	10	1/6/90	811168	944
	16	1/6/90	811170	944
	20	1/6/90	811171	944
	25	1/6/90	811172	944
	32	1/6/90	811173	944
	40	1/6/90	811174	1370
	50	1/6/90	811175	1536
	63	1/6/90	811176	1536

6

C CURVE THREE POLE

HSN Code: 8536

	Rating (A)	Pack	Cat. Nos.	Unit Price (₹)
	0.5	1/4/60	811180	1720
	1	1/4/60	811181	1720
	2	1/4/60	811183	1720
	3	1/4/60	811185	1720
	4	1/4/60	811186	1720
	5	1/4/60	811187	1720
	6	1/4/60	811188	1474
	10	1/4/60	811190	1474
	16	1/4/60	811192	1474
	20	1/4/60	811193	1474
	25	1/4/60	811194	1474
	32	1/4/60	811195	1474
	40	1/4/60	811196	2138
	50	1/4/60	811197	2260
	63	1/4/60	811198	2260

—optipro— **MINIATURE CIRCUIT BREAKER - MCB**

C CURVE THREE POLE NEUTRAL

HSN Code: 8536

	Rating (A)	Pack	Cat. Nos.	Unit Price (₹)
	0.5	1/3/45	811202	2208
1	1/3/45	811203	2208	
2	1/3/45	811205	2208	
3	1/3/45	811207	2208	
4	1/3/45	811208	2208	
5	1/3/45	811209	2208	
6	1/3/45	811210	1900	
10	1/3/45	811212	1900	
16	1/3/45	811214	1900	
20	1/3/45	811215	1900	
25	1/3/45	811216	1900	
32	1/3/45	811217	1900	
40	1/3/45	811218	2530	
50	1/3/45	811219	2678	
63	1/3/45	811220	2678	

C CURVE FOUR POLE

HSN Code: 8536

	Rating (A)	Pack	Cat. Nos.	Unit Price (₹)
	0.5	1/3/45	811224	2242
1	1/3/45	811225	2242	
2	1/3/45	811227	2242	
3	1/3/45	811229	2242	
4	1/3/45	811230	2242	
5	1/3/45	811231	2242	
6	1/3/45	811232	2104	
10	1/3/45	811234	2104	
16	1/3/45	811236	2104	
20	1/3/45	811237	2104	
25	1/3/45	811238	2104	
32	1/3/45	811239	2104	
40	1/3/45	811240	2856	
50	1/3/45	811241	2920	
63	1/3/45	811242	2920	

D CURVE SINGLE POLE

HSN Code: 8536

	Rating (A)	Pack	Cat. Nos.	Unit Price (₹)
	0.5	1/12/180	811246	478
1	1/12/180	811247	478	
2	1/12/180	811249	478	
3	1/12/180	811251	478	
4	1/12/180	811252	478	
5	1/12/180	811253	478	
6	1/12/180	811254	408	
10	1/12/180	811256	408	
16	1/12/180	811258	408	
20	1/12/180	811259	408	
25	1/12/180	811260	408	
32	1/12/180	811261	408	
40	1/12/180	811262	674	
50	1/12/180	811263	768	
63	1/12/180	811264	768	

—optipro™— **MINIATURE CIRCUIT BREAKER - MCB**

D CURVE DOUBLE POLE

HSN Code: 8536

	Rating (A)	Pack	Cat. Nos.	Unit Price (₹)
	0.5	1/6/90	811284	1264
	1	1/6/90	811285	1264
	2	1/6/90	811287	1264
	3	1/6/90	811289	1264
	4	1/6/90	811290	1264
	5	1/6/90	811291	1264
	6	1/6/90	811292	984
	10	1/6/90	811294	984
	16	1/6/90	811296	984
	20	1/6/90	811297	984
	25	1/6/90	811298	984
	32	1/6/90	811299	984
	40	1/6/90	811300	1412
	50	1/6/90	811301	1502
	63	1/6/90	811302	1502

D CURVE THREE POLE

HSN Code: 8536

	Rating (A)	Pack	Cat. Nos.	Unit Price (₹)
	0.5	1/4/60	811303	1872
	1	1/4/60	811304	1872
	2	1/4/60	811306	1872
	3	1/4/60	811308	1872
	4	1/4/60	811309	1872
	5	1/4/60	811310	1872
	6	1/4/60	811311	1498
	10	1/4/60	811313	1498
	16	1/4/60	811315	1498
	20	1/4/60	811316	1498
	25	1/4/60	811317	1498
	32	1/4/60	811318	1498
	40	1/4/60	811319	2260
	50	1/4/60	811320	2288
	63	1/4/60	811321	2288

D CURVE FOUR POLE

HSN Code: 8536

	Rating (A)	Pack	Cat. Nos.	Unit Price (₹)
	0.5	1/3/45	811341	2270
	1	1/3/45	811342	2270
	2	1/3/45	811344	2270
	3	1/3/45	811346	2270
	4	1/3/45	811347	2270
	5	1/3/45	811348	2270
	6	1/3/45	811349	1958
	10	1/3/45	811351	1958
	16	1/3/45	811353	1958
	25	1/3/45	811355	1958
	32	1/3/45	811356	1958
	40	1/3/45	811357	2796
	50	1/3/45	811358	2896
	63	1/3/45	811359	2896

—optipro™— **AC CIRCUIT BREAKER**

- Conforms to IEC 60947-2 • CE Marked • Rated Short-Circuit Capacity, Icu 10kA • Degree of Protection IP 20
- 1.5 Module per pole • 50 sq. mm Terminals • Frequency: 50 Hz • Operating Voltage: 240V/415V AC, 60V DC per Pole

SINGLE POLE

HSN Code: 8536

	Rating (A)	Pack	Cat. Nos.	Unit Price (₹)
	80	1	811133	2410
	100	1	811134	2672
	125	1	811135	2976

DOUBLE POLE

HSN Code: 8536

	Rating (A)	Pack	Cat. Nos.	Unit Price (₹)
	80	1	811177	5574
	100	1	811178	5996
	125	1	811179	6572

THREE POLE

HSN Code: 8536

	Rating (A)	Pack	Cat. Nos.	Unit Price (₹)
	80	1	811199	8166
	100	1	811200	8800
	125	1	811201	9562

FOUR POLE

HSN Code: 8536

	Rating (A)	Pack	Cat. Nos.	Unit Price (₹)
	80	1	811243	10672
	100	1	811244	11020
	125	1	811245	12530

—optipro™— **DC CIRCUIT BREAKER**

- Conforms to IEC 60947-2 • CE Marked • Breaking Capacity 6kA • Degree of Protection IP 20 • 35 sq. mm Terminals
- Biconnect Terminals • Upto 250V Supply

SINGLE POLE

HSN Code: 8536

	Rating (A)	Pack	Cat. Nos.	Unit Price (₹)
	0.5	1/12/180	811400	624
	1	1/12/180	811401	624
	2	1/12/180	811403	624
	3	1/12/180	811405	624
	4	1/12/180	811406	624
	5	1/12/180	811407	624
	6	1/12/180	811408	560
	10	1/12/180	811410	560
	16	1/12/180	811412	560
	20	1/12/180	811413	560
	25	1/12/180	811414	560
	32	1/12/180	811415	560
	40	1/12/180	811416	742
	50	1/12/180	811417	766
	63	1/12/180	811418	766

—optipro™— DC CIRCUIT BREAKER

DOUBLE POLE

HSN Code: 8536

	Rating (A)	Pack	Cat. Nos.	Unit Price (₹)
	0.5	1/6/90	811419	1414
1	1/6/90	811420	1414	
2	1/6/90	811422	1414	
3	1/6/90	811424	1414	
4	1/6/90	811425	1414	
5	1/6/90	811426	1414	
6	1/6/90	811427	1160	
10	1/6/90	811429	1160	
16	1/6/90	811431	1160	
20	1/6/90	811432	1160	
25	1/6/90	811433	1160	
32	1/6/90	811434	1160	
40	1/6/90	811435	1584	
50	1/6/90	811436	1702	
63	1/6/90	811437	1702	

OPTIPRO DC MCB WITH EXTENDED LINK AS PER RDSO

HSN Code: 8536

Rating (A)	Pack	Cat. Nos.	Unit Price (₹)
0.5	1/-/48	811451	668
1	1/-/48	811452	668
1.5	1/-/48	811453	668
1.6	1/-/48	811454	668
2	1/-/48	811455	668
2.5	1/-/48	811456	668
3	1/-/48	811457	668
4	1/-/48	811458	668
5	1/-/48	811459	668
6	1/-/48	811460	626
7.5	1/-/48	811461	626
10	1/-/48	811462	626
15	1/-/48	811463	626
16	1/-/48	811464	626
20	1/-/48	811465	626
25	1/-/48	811466	626
30	1/-/48	811467	626
35	1/-/48	811468	828
40	1/-/48	811469	828
50	1/-/48	811470	828
60	1/-/48	811471	828

—optipro™— **ISOLATOR**

- Conforms to IEC 60947-3 • CE Marked • Degree of Protection IP 20 • 35 sq. mm Terminals • Biconnect Terminals
- Frequency: 50 Hz • Operating Voltage: 240V/415V AC, 60V DC per Pole

DOUBLE POLE

HSN Code: 8536

	Rating (A)	Pack	Cat. Nos.	Unit Price (₹)
	40	1/6/90	811550	586
	63	1/6/90	811551	724
	80	1/6/90	811552	934
	100	1/6/90	811553	934
	125	1/6/90	811554	1008

THREE POLE

HSN Code: 8536

	Rating (A)	Pack	Cat. Nos.	Unit Price (₹)
	40	1/4/60	811555	1096
	63	1/4/60	811556	1254
	80	1/4/60	811557	1414
	100	1/4/60	811558	1414
	125	1/4/60	811559	1550

FOUR POLE

HSN Code: 8536

	Rating (A)	Pack	Cat. Nos.	Unit Price (₹)
	40	1/3/45	811560	1310
	63	1/3/45	811561	1414
	80	1/3/45	811562	1754
	100	1/3/45	811563	1754
	125	1/3/45	811564	1898

—optipro™— **RESIDUAL CURRENT CIRCUIT BREAKER - RCCB**

- ISI/CE marked as per IS/IEC 12640-1 • Degree of Protection IP 20 • Rated Conditional Short-Circuit Current, Icc10kA
- 35 sq. mm Terminals • Biconnect Terminals • Frequency: 50 Hz • Operating Voltage: 240V/415V AC

DOUBLE POLE

HSN Code: 8536

	Rating (A)	Sensitivity (mA)	Pack	Cat. Nos.	Unit Price (₹)
	25	30	1/6/90	811700	3266
		100	1/6/90	811706	3266
		300	1/6/90	811712	3400
	40	30	1/6/90	811701	3354
		100	1/6/90	811707	3354
		300	1/6/90	811713	3656
	63	30	1/6/90	811702	4484
		100	1/6/90	811708	4484
		300	1/6/90	811714	4582

FOUR POLE

HSN Code: 8536

	Rating (A)	Sensitivity (mA)	Pack	Cat. Nos.	Unit Price (₹)
	25	30	1/3/45	811718	4188
		100	1/3/45	811724	4188
		300	1/3/45	811730	4348
	40	30	1/3/45	811719	4296
		100	1/3/45	811725	4296
		300	1/3/45	811731	4534
	63	30	1/3/45	811720	4648
		100	1/3/45	811726	4648
		300	1/3/45	811732	4730

—optipro™— **RCD ADD ON BLOCK**

- Conforms to IEC 60947-2 • Degree of Protection IP 20
- Rated Conditional Short-Circuit Current, Icc 10kA • 35 sq. mm Terminals • Dual Position DIN Clip

DOUBLE POLE

HSN Code: 8536

	Rating (A)	Sensitivity (mA)	Pack	Cat. Nos.	Unit Price (₹)
	6A - 32A		30	1/ - /32	811666
		100	1/ - /32	811668	3592
		300	1/ - /32	811670	3866
40A & 63A		30	1/ - /32	811667	3866
		100	1/ - /32	811669	4248
		300	1/ - /32	811671	4636

FOUR POLE

HSN Code: 8536

	Rating (A)	Sensitivity (mA)	Pack	Cat. Nos.	Unit Price (₹)
	6A - 32A		30	1/ - /16	811672
		100	1/ - /16	811674	4078
		300	1/ - /16	811676	4254
40A & 63A		30	1/ - /16	811673	4376
		100	1/ - /16	811675	4758
		300	1/ - /16	811677	5132

—optipro™— **ACCESSORIES**

HSN Code: 8538

- Conforms to IEC 60947 - 5 - 1 • Retro Fit Type Clip On Accessory • CE Marked
- Upto Three Number of Accessory on a Modular Device • Common Accessories for Entire Range • Easy To Install

	Item Description	Pack	Cat. Nos.	Unit Price (₹)
		Auxiliary Changeover Switch 1NC	1	811580
	Fault Signalling Contact 1NC	1	811581	1034
	Shunt Trip 12V to 48V AC/DC	1	811582	1780
	Shunt Trip 110V to 415V AC	1	811583	1780
	Undervoltage 24V & 48V AC/DC	1	811584	1554
	Undervoltage 240V AC	1	811585	1554

—optipro™— DISTRIBUTION BOARDS (DBs)

SPN DB-SINGLE DOOR

HSN Code: 8537

- IP : 30 Protection
- Door Earthing
- Isolated Neutral Bar
- Mechanical Impact Strength IK 08
- Cement Spill Protector

	Ways	Modules	Cat Ref.	Unit Price (₹)
	4	4	811800	1420
	6	6	811801	1486
	8	8	811802	1740
	12	12	811803	2038
	16	16	811804	2546

SPN DB-DOUBLE DOOR

HSN Code: 8537

- IP : 43 Protection
- Door Earthing
- Isolated Neutral Bar
- Mechanical Impact Strength IK 09
- Cement Spill Protector

	Ways	Modules	Cat Ref.	Unit Price (₹)
	4	4	811805	2122
	6	6	811806	2292
	8	8	811807	2376
	10	10	811812	2716
	12	12	811808	2864
	14	14	811810	3140
	16	16	811809	3478
	18	18	811811	3820

SPN DB -DOUBLE DOOR

HSN Code: 8537

- IP : 54 Protection
- Door Earthing
- Isolated Neutral Bar
- Mechanical Impact Strength IK 09
- Cement Spill Protector

	Ways	Modules	Cat Ref.	Unit Price (₹)
	4	4	811824	3268
	6	6	811825	3990
	8	8	811826	4264
	12	12	811828	5516
16	16	811829	6810	

SPN DB-ACRYLIC DOOR

HSN Code: 8537

- IP : 43 Protection
- Door Earthing
- Isolated Neutral Bar
- Cement Spill Protector

	Ways	Modules	Cat Ref.	Unit Price (₹)
	4	4	811816	2228
	6	6	811817	2652
	8	8	811818	2800
	12	12	811819	3438
16	16	811820	4244	

—optipro™— **DISTRIBUTION BOARDS (DBs)**

TPN DB-SINGLE DOOR

HSN Code: 8537

- IP : 30 Protection
- Door Earthing
- Isolated Neutral Bar
- Mechanical Impact Strength IK 08
- Cement Spill Protector

	Ways	Modules	Cat Ref.	Unit Price (₹)
	4 Way compact	4+12	811832	3542
	4 Way	8+12	811833	3736
	6 Way compact	4+18	811834	4328
	6 Way	8+18	811835	4624
	8 Way	8+24	811836	5474
	12 Way	8+36	811837	7872
	16 Way	8+48	811838	9696

TPN DB-DOUBLE DOOR

HSN Code: 8537

- IP : 43 Protection
- Door Earthing
- Isolated Neutral Bar
- Mechanical Impact Strength IK 09
- Cement Spill Protector

	Ways	Modules	Cat Ref.	Unit Price (₹)
	4 Way compact	4+12	811840	4392
	4 Way	8+12	811841	4604
	6 Way compact	4+18	811842	5410
	6 Way	8+18	811843	5750
	8 Way	8+24	811844	6896
	12 Way	8+36	811845	10332
	16 Way	8+48	811846	12838

TPN DB-DOUBLE DOOR

HSN Code: 8537

- IP : 54 Protection
- Door Earthing
- Isolated Neutral Bar
- Mechanical Impact Strength IK 09
- Cement Spill Protector

	Ways	Modules	Cat Ref.	Unit Price (₹)
	4 Way compact	4+12	811856	8190
	4 Way	8+12	811857	9252
	6 Way compact	4+18	811858	10608
	6 Way	8+18	811859	11564
	8 Way	8+24	811860	14364
	12 Way	8+36	811861	20412
	16 Way	8+48	811862	24400

TPN DB-ACRYLIC DOOR

HSN Code: 8537

- IP : 43 Protection
- Door Earthing
- Isolated Neutral Bar
- Cement Spill Protector

	Ways	Modules	Cat Ref.	Unit Price (₹)
	4 Way compact	4+12	811848	5496
	4 Way	8+12	811849	5984
	6 Way compact	4+18	811850	6960
	6 Way	8+18	811851	7468
	8 Way	8+24	811852	9292
	12 Way	8+36	811853	13154
	16 Way	8+48	811854	15892

—optipro™— DISTRIBUTION BOARDS (DBs)

VTPN MCB DB-SINGLE DOOR

HSN Code: 8537

- IP : 30 Protection
- Door Earthing
- Isolated Neutral Bar
- Mechanical Impact Strength IK 08
- Insulated busbar assembly

	Ways	Modules	Cat Ref.	Unit Price (₹)
	4 Way	8 + 12	811864	10120
	6 Way	8 + 18	811865	11118
	8 Way	8 + 24	811866	12370
	12 Way	8 + 36	811867	16634

VTPN MCB DB-DOUBLE DOOR

- IP : 43 Protection
- Door Earthing
- Isolated Neutral Bar
- Mechanical Impact Strength IK 09
- Insulated busbar assembly

	Ways	Modules	Cat Ref.	Unit Price (₹)
	4 Way	8 + 12	811870	11374
	6 Way	8 + 18	811871	13516
	8 Way	8 + 24	811872	14832
	12 Way	8 + 36	811873	18990

VTPN MCB DB -DOUBLE DOOR

HSN Code: 8537

- IP : 54 Protection
- Door Earthing
- Isolated Neutral Bar
- Mechanical Impact Strength IK 09
- Cement Spill Protector

	Ways	Modules	Cat Ref.	Unit Price (₹)
	4 Way	8 + 12	811882	17314
	6 Way	8 + 18	811883	21876
	8 Way	8 + 24	811884	26606
	12 Way	8 + 36	811885	33460

VTPN MCCB 125A DB-DOUBLE DOOR

HSN Code: 8537

- IP : 43 Protection
- Door Earthing
- Isolated Neutral Bar
- Mechanical Impact Strength IK 09
- Insulated busbar assembly
- Suitable for MCCB's upto 125A as I/C (Frame1)

	Ways	Modules	Cat Ref.	Unit Price (₹)
	4 Way	Optium F1 + 12	811888	13302
	6 Way	Optium F1 + 18	811889	15042
	8 Way	Optium F1 + 24	811890	16422
	12 Way	Optium F1 + 36	811891	22364

VTPN MCCB 125A DB -DOUBLE DOOR

HSN Code: 8537

- IP : 54 Protection
- Door Earthing
- Isolated Neutral Bar
- Mechanical Impact Strength IK 09
- Cement Spill Protector
- Suitable for MCCB's upto 125A as I/C (Frame1)

	Ways	Modules	Cat Ref.	Unit Price (₹)
	4 Way	Optium F1 + 12	812040	22300
	6 Way	Optium F1 + 18	812041	25228
	8 Way	Optium F1 + 24	812042	26988
	12 Way	Optium F1 + 36	812043	36388

—optipro™— DISTRIBUTION BOARDS (DBs)

VTPN MCCB 250A DB-DOUBLE DOOR

HSN Code: 8537

- IP : 43 Protection
- Door Earthing
- Isolated Neutral Bar
- Mechanical Impact Strength IK 09
- Insulated busbar assembly
- Suitable for MCCB's upto 250A as I/C (Frame 2)

	Ways	Modules	Cat Ref.	Unit Price (₹)
	4 Way	Optium F2+ 12	811893	18650
	6 Way	Optium F2+ 18	811894	19818
	8 Way	Optium F2+ 24	811895	21918
	12 Way	Optium F2+ 36	811896	27880

VTPN MCCB 250A DB -DOUBLE DOOR

HSN Code: 8537

- IP : 54 Protection
- Door Earthing
- Isolated Neutral Bar
- Mechanical Impact Strength IK 09
- Cement Spill Protector
- Suitable for MCCB's upto 250A as I/C (Frame 2)

	Ways	Modules	Cat Ref.	Unit Price (₹)
	4 Way	Optium F2+ 12	812045	36176
	6 Way	Optium F2+ 18	812046	38596
	8 Way	Optium F2+ 24	812047	42668
	12 Way	Optium F2+ 36	812048	47932

FLEXI DB-DOUBLE DOOR

HSN Code: 8537

- IP : 43 Protection
- Door Earthing
- Isolated Neutral Bar
- Mechanical Impact Strength IK 09
- Cement Spill Protector

	Ways	Modules	Cat Ref.	Unit Price (₹)
	14 X 2 Row	28	811912	6004
	14 X 3 Row	42	811913	7150
	14 X 4 Row	56	811915	7936

FLEXI DB -DOUBLE DOOR

HSN Code: 8537

- IP : 54 Protection
- Door Earthing
- Isolated Neutral Bar
- Mechanical Impact Strength IK 09
- Cement Spill Protector

	Ways	Modules	Cat Ref.	Unit Price (₹)
	14 X 2 Row	28	812030	9676
	14 X 3 Row	42	812031	11798
	14 X 4 Row	56	812033	13008

—optipro™— DISTRIBUTION BOARDS (DBs)

7 SEGMENT DB-DOUBLE DOOR

HSN Code: 8537

- IP : 43 Protection
- Door Earthing
- Isolated Neutral Bar
- Mechanical Impact Strength IK 09
- Compartmentalized solution

	Ways	Modules	Cat Ref.	Unit Price (₹)
	4 Way	8 + 12 + 12	811925	11754
	6 Way	8 + 12 + 18	811926	13176
	8 Way	8 + 12 + 24	811927	14852
	12 Way	8 + 12 + 36	811928	18374
	16 Way	8 + 12 + 48	811929	18884

PHASE SELECTOR DB 40A DOUBLE DOOR

HSN Code: 8537

- IP : 43 Protection
- Door Earthing
- 40 A prefitted selector switch
- Mechanical Impact Strength IK 09
- Isolated Neutral Bar

	Ways	Modules	Cat Ref.	Unit Price (₹)
	4 Way	8 + 12	811940	13920
	6 Way	8 + 18	811941	14534
	8 Way	8 + 24	811942	15764
	12 Way	8 + 36	811943	17482

PHASE SELECTOR DB 63A DOUBLE DOOR

HSN Code: 8537

- IP : 43 Protection
- Door Earthing
- 63 A prefitted selector switch
- Mechanical Impact Strength IK 09
- Isolated Neutral Bar

	Ways	Modules	Cat Ref.	Unit Price (₹)
	4 Way	8 + 12	811950	16062
	6 Way	8 + 18	811951	16760
	8 Way	8 + 24	811952	17676
	12 Way	8 + 36	811953	19880

METAL CLAD P&S

HSN Code: 8537

- IP : 30 Protection
- Without MCBs
- Mechanical Impact Strength IK 08

	Ways	Modules	Cat Ref.	Unit Price (₹)
	20A 2P+E	1 Mod	811955	1570
	20A 2P+E	2 Mod	811956	1570
	20A 3P+E	3 Mod	811957	3478
	32A 3P+E	3 Mod	811958	4136

—optipro™— **DISTRIBUTION BOARDS (DBs)**

TV/TEL DB

HSN Code: 8537

- IP : 43 Protection
- Door Earthing
- Factory fitted KRONE type TV & TEL socket
- Mechanical Impact Strength IK 09
- Isolated & Shrouded Neutral Bar

	Ways	Modules	Cat Ref.	Unit Price (₹)
	8 Way SPN	8	811963	4688
	12 Way SPN	12	811964	5282
	16 Way SPN	16	811965	6024
	4 Way TPN	8+12	811967	7808
	6 Way TPN	8+18	811983	8784
	8 Way TPN	8+24	811968	9844

PPI DB-DOUBLE DOOR

HSN Code: 8537

- IP : 43 Protection
- Door Earthing
- Isolated Neutral Bar for individual phase
- Mechanical Impact Strength IK 09
- Cement Spill Protector

	Ways	Modules	Cat Ref.	Unit Price (₹)
	Hori 4+2 Way	8+6+12	811971	8020
	Hori 6+2 Way	8+6+18	811972	9844
	Hori 8+2 Way	8+6+24	811973	11648
	Hori 12+2 Way	8+6+36	811998	14348
	Tier 6+2 Way	8+6+18	811974	9526
	Tier 8+2 Way	8+6+24	811975	11882
	Tier 12+2 Way	8+6+36	811976	14152

PPI DB-DOUBLE DOOR

HSN Code: 8537

- IP :54 Protection
- Door Earthing
- Isolated Neutral Bar
- Mechanical Impact Strength IK 09
- Cement Spill Protector

	Ways	Modules	Cat Ref.	Unit Price (₹)
	Hori 4+2 Way	8+6+12	812034	15298
	Hori 6+2 Way	8+6+18	812035	18756
	Hori 8+2 Way	8+6+24	812036	21260
	Tier 6+2 Way	8+6+18	812037	15510
	Tier 8+2 Way	8+6+24	812038	19372
	Tier 12+2 Way	8+6+36	812039	22534

PLASTIC P&S

HSN Code: 8537

- IP : 30 Protection
- Without MCBs

	Ways	Modules	Cat Ref.	Unit Price (₹)
	16A 2P+E	2 Mod	811959	3162
	32A 2P+E	2 Mod	811960	3248
	32A 3P+N+E	4 Mod	811961	5198
	63A 3P+N+E	4 Mod	811962	13706

— optipro™ — DISTRIBUTION BOARDS (DBs)

ENCLOSURES

HSN Code: 8537

	Ways	Modules	Cat Ref.	Unit Price (₹)
	1/2 Mod plastic	2	811977	212
	3/4 Mod plastic	4	811978	360
	1 Mod metal	1	811979	530
	2 Mod metal	2	811980	530
	3 Mod metal	3	811981	702
	4 Mod metal	4	811982	702

CABLE END BOX

HSN Code: 8537

- IP : 43 Protection
- Mechanical Impact Strength IK08

Description	Cat Ref.	Unit Price (₹)
CEB SPN DD 4W DB	812000	938
CEB SPN DD 6W DB	812001	1002
CEB SPN DD 8W DB	812002	1068
CEB SPN DD 10W DB	812003	1194
CEB SPN DD 12W DB	812004	1258
CEB SPN DD 14W DB	812005	1344
CEB SPN DD 16W DB	812006	1514
CEB SPN DD 18W DB	812007	1622
CEB TPN DD 4W 4 POLE I/C DB	812008	1152
CEB TPN DD 4W 8 POLE I/C DB or CEB TPN 6W4P I/C DB	812009	1386
CEB TPN DD 6W 8P I/C DB or PPI HORI. DD DB 4+2W	812010	1642
CEB TPN DD 8W DB or PPI HORI. DD DB 6+2W	812011	2024
CEB TPN DD 10W DB or PPI HORI. DD DB 8+2W	812012	2366
CEB TPN DD 12W DB	812013	2772
CEB TPN DD 16W DB	812014	2836
CEB VTPN MCB I/C DB or VTPN MCCB I/C DD DB	812015	2216
CEB FLEXY DD 14 MOD. PER ROW DB	812017	2004
CEB PPI TIER 6+2W	812018	1984
CEB PPI TIER 8+2W	812019	2346
CEB PPI TIER 12+2W	812020	2474

MCCB ENCLOSURE

- Solid Neutral Link for 3 Pole MCCBs

Description	Pack	Cat. Nos.	Unit Price (₹)
Optipro Enclosure for Frame-1 Optium 3 Pole MCCB	1	811984	1940
Optipro Enclosure for Frame-1 Optium 4 Pole MCCB	1	811985	1940
Optipro Enclosure for Frame-2 Optium 3 Pole MCCB	1	811986	3006
Optipro Enclosure for Frame-2 Optium 4 Pole MCCB	1	811987	3006
Optipro Enclosure for Frame-3 Optium 3 Pole MCCB	1	811988	3006
Optipro Enclosure for Frame-3 Optium 4 Pole MCCB	1	811989	3006
Optipro Enclosure for Frame-4 Optium 3 Pole MCCB	1	811990	7484
Optipro Enclosure for Frame-4 Optium 4 Pole MCCB	1	811991	7484

**BUSBAR CHAMBER
TPN BBC (Cu-Busbar)**

HSN Code: 8536

	<p>Solution for safe Power Distribution</p> <ul style="list-style-type: none"> • Step type design • Available in both SPN & TPN configuration 	Item Description	Ingress Protection*	Cat Ref.	Unit Price* (₹)
		Spl. 32A TPN BBC (Cu) with 4 o/g ways	IP42	CPPI1015	8074
		Spl. 63A TPN BBC (Cu) with 4 o/g ways	IP42	CPPI1016	9006
		Spl. 100A TPN BBC (Cu) with 4 o/g ways	IP42	CPPI1017	9978
		Spl. 200A TPN BBC (Cu) with 4 o/g ways	IP42	CPPI1018	12342
		Spl. 250A TPN BBC (Cu) with 4 o/g ways	IP42	CPPI1019	17566
		Spl. 320A TPN BBC (Cu) with 4 o/g ways	IP42	CPPI1020	21342
		Spl. 400A TPN BBC (Cu) with 4 o/g ways	IP42	CPPI1021	23714
		Spl. 630A TPN BBC (Cu) with 4 o/g ways	IP42	CPPI1022	37936

*Also available in IP54 design

**BUSBAR CHAMBER
TPN-Type (Al.Busbar)**

HSN Code: 8536

	<p>Solution for safe Power Distribution</p> <ul style="list-style-type: none"> • Step type design • Available in both SPN & TPN configuration 	Item Description	Ingress Protection*	Cat Ref.	Unit Price* (₹)
		Spl. 32A TPN BBC (Al.) with 4 o/g ways	IP42	CPPI1023	7590
		Spl. 63A TPN BBC (Al.) with 4 o/g ways	IP42	CPPI1024	8074
		Spl. 100A TPN BBC (Al.) with 4 o/g ways	IP42	CPPI1025	8520
		Spl. 200A TPN BBC (Al.) with 4 o/g ways	IP42	CPPI1026	9006
		Spl. 250A TPN BBC (Al.) with 4 o/g ways	IP42	CPPI1027	10886
		Spl. 320A TPN BBC (Al.) with 4 o/g ways	IP42	CPPI1028	11856
		Spl. 400A TPN BBC (Al.) with 4 o/g ways	IP42	CPPI1029	12342
		Spl. 630A TPN BBC (Al.) with 4 o/g ways	IP42	CPPI1008	21212

*Also available in IP54 design

**METAL CLAD PLUG & SOCKET
AC PLUG**

HSN Code: 8536

	Rating	Pack	Cat. Nos.	Unit Price (₹)
	10A 2P+E, 230V AC	1/10/100	810385	184
	20A 2P+E, 230V AC	1/10/100	810386	198
	20A 3P+E, 230V / 415V AC	1/10/100	810387	268
	32A 3P+E, 230V / 415V AC	1/10/100	810388	484

AC SOCKET

HSN Code: 8536

	Rating	Pack	Cat. Nos.	Unit Price (₹)
	10A 2P+E, 230V AC	1/10/100	810389	184
	20A 2P+E, 230V AC	1/10/100	810390	212
	20A 3P+E, 230V / 415V AC	1/10/100	810391	280
	32A 3P+E, 230V / 415V AC	1/10/100	810392	484

TIME SWITCHES

ANALOG TIME SWITCHES (with battery back up)

HSN Code: 9107

	Model Name	Description	Cat Ref.	Unit Price (₹)
	1mod DIN Daily	1P Module, 24 hours program, Programmable every 15 min., backup of 100 hours, current capacity 16A, with 1 changeover (1 CO)	TA916422	3906
	3mod DIN Daily	3P Module, 24 hours program, Programmable every 15 min., backup of 100 hrs., current capacity 16A, with 1 changeover (1 CO)	TA926453	4254
	Front Mounted Daily	Front Mounting, 24 hours program, Programmable every 20 min., back up of 100 hrs., current capacity 16A, with 1 changeover (1 CO)	TA912472*	3906
	3mod DIN Weekly	Weekly program, Programmable every 4 hrs., with back up of 100 hrs., current capacity 16A, with 1 changeover (1 CO)	TA926129*	4648

*Discontinued product, available till stock lasts.

ANALOG TIME SWITCHES (without battery back up)

HSN Code: 9107

	Model Name	Description	Cat Ref.	Unit Price (₹)
	3mod DIN Daily	3P Module, 24 hours program, Programmable every 15 min., current capacity 16A, with 1 changeover (1 CO)	TA925450*	3590
	Front Mounted Daily	Front Mounting, 24 hours program, Programmable every 20 min., current capacity 16A, with 1 changeover (1 CO)	TA912473*	3232

*Discontinued product, available till stock lasts.

DIGITAL TIME SWITCHES

HSN Code: 9107

	Model Name	Description	Cat Ref.	Unit Price (₹)
	DIN Type Daily / Weekly with 1 CO	Programmable every 1 min., with backup of 6 years, 28 memory locations, current capacity 16A, weekly program, with 1 changeover (1 CO), Total 28 programs	TDA43110	5170
	DIN Type Daily / Weekly with 2 CO	Programmable every 1 min., with backup of 6 years, 28 memory locations, current capacity 16A, weekly program, with 2 changeover (2 CO), Total 14 programs per channel	TDA43111	7760
	DIN Type Astronomical with 1 CO	Astronomical Programmable every 1 min., backup of 6 years, 28 memory locations, current capacity 16A, with 1 changeover (1 CO), Total 28 programs	TDA45163	10764
	DIN Type Astronomical with 2 CO	Astronomical Programmable every 1 min., backup of 6 years, 28 memory locations, current capacity 16A, with 2 changeover (2 CO), Total 14 programs per channel	TDA45164	13450

LIGHT SENSITIVE SWITCHES

HSN Code: 9107

	Model Name	Description	Cat Ref.	Unit Price (₹)
	1mod DIN Light	Light sensitive switch with outer sensor, sensitive distance 50m,	TSA58107	8970

TIMELITE DISTRIBUTION BOARDS

HSN Code: 8537

Description	Cat Ref.	Unit Price (₹)	
		Unit Price (₹)	Unit Price (₹)
Timelite-16A 3Pole/230V-Analog Time switch	TL016AB0	25226	
Timelite-32A 3Pole/230V-Analog Time switch	TL032AB0	27288	
Timelite-32A 3Pole/230V-Digital Time Switch	TL032DB0	29782	
Timelite-32A 3Pole/230V-Astronomical Time Switch	TL032AS0	34754	
Timelite-40A 3Pole/230V-Analog Time Switch	TL040AB0	29396	
Timelite-40A 3Pole/230V-Digital Time Switch	TL040DB0	31838	
Timelite-40A 3Pole/230V-Astronomical Time Switch	TL040AS0	36814	
Timelite-65A 3Pole/230V-Analog Time Switch	TL065AB0	37630	
Timelite-65A 3Pole/230V-Digital Time Switch	TL065DB0	40116	
Timelite-65A 3Pole/230V-Astronomical Time Switch	TL065AS0	45068	
Timelite-110A 3Pole/230V-Analog Time Switch	TL110AB0	62996	
Timelite-110A 3Pole/230V-Digital Time Switch	TL110DB0	64916	
Timelite-110A 3Pole/230V-Astronomical Time Switch	TL110AS0	70538	
The analog time switch which will be used in Timelite DBs is TA926453 The digital time switch which will be used in Timelite DBs is TDA43110 The astronomical time switch which will be used in Timelite DBs is TDA45163			

GSM based SMART Timelite DB's are also available on request.

AUTOMATIC CHANGEOVER WITH CURRENT LIMITER

- As per IEC60947-6-1
- Intelligent micro controller based Design
- RoHS Compliant

HSN Code: 8536

Rating (A)	Pack	Cat. Nos.	Unit Price (₹)
SPN 30A Mains 1.5A DG ACCL	1/3/45	810409	2130
SPN 30A Mains 2.5A DG ACCL	1/3/45	810410	2130
SPN 30A Mains 3A DG ACCL	1/3/45	810400	2130
SPN 30A Mains 4A DG ACCL	1/3/45	810401	2130
SPN 30A Mains 5A DG ACCL	1/3/45	810402	2130
SPN 30A Mains 6A DG ACCL	1/3/45	810403	2130
SPN 30A Mains 9A DG ACCL	1/3/45	810404	2130
SPN 30A Mains 12A DG ACCL	1/3/45	810405	2130
SPN 30A Mains 15A DG ACCL	1/3/45	810406	2130
SPN 30A Mains 20A DG ACCL	1/3/45	810407	2130
SPN 30A Mains 30A DG ACCL	1/3/45	810408	2130

ENSURING RELIABLE PERFORMANCE AT HIGH AMBIENT & HUMID ENVIRONMENTS.



— optium™ —

ALL THAT YOU NEED

MCCB

- COMPREHENSIVE PROTECTION - PROTECTED NEUTRAL
- ROBUST PERFORMANCE - NO DE-RATING UPTO 50 DEGREE C
- SAFE - HIGH PHASE-PHASE CLEARANCES
- EASY TO MANAGE - ONLY TWO SIZES OF INTERNAL ACCESSORIES
- INTELLIGENT -ALARMS & PRE-ALARMS FOR ELECTRONIC RANGE

—optium™— **OPTIUM 1.0E (FIXED TM MCCB RANGE)**

- Ics =50% Icu as per IEC 60947-II
- Class II front face
- Suitable for isolation
- Fixed Overload & fixed short circuit setting

HSN Code: 8536

Image	Frame	Breaking capacity	Rating	3P	Unit Price (₹)	4P	Unit Price (₹)
		F1	10kA	16	830701	2758	830710
F1		10kA	25	830702	2758	830711	3348
F1		10kA	32	830703	2758	830712	3348
F1		10kA	40	830704	2758	830713	3348
F1		10kA	50	830705	2758	830714	3348
F1		10kA	63	830706	2758	830715	3348
F1		10kA	80	830707	3108	830716	3976
F1		10kA	100	830708	3122	830717	3996
F1		10kA	125	830709	4452	830718	5752

HSN Code: 8536

Image	Frame	Breaking capacity	Rating	3P	Unit Price (₹)	4P	Unit Price (₹)
		F1	16kA	16	830001	4592	830015
F1		16kA	25	830002	4592	830016	5608
F1		16kA	32	830003	4592	830017	5608
F1		16kA	40	830004	4592	830018	5608
F1		16kA	50	830005	4592	830019	5608
F1		16kA	63	830006	4592	830020	5608
F1		16kA	80	830007	4822	830021	6208
F1		16kA	100	830008	4822	830022	6208
F1		16kA	125	830009	6680	830023	8780

HSN Code: 8536

Image	Frame	Breaking capacity	Rating	3P	Unit Price (₹)	4P	Unit Price (₹)
		F1	25kA	16	830031	5526	830045
F1		25kA	25	830032	5526	830046	6606
F1		25kA	32	830033	5526	830047	6606
F1		25kA	40	830034	5526	830048	6606
F1		25kA	50	830035	5526	830049	6606
F1		25kA	63	830036	5526	830050	6606
F1		25kA	80	830037	5690	830051	6934
F1		25kA	100	830038	5690	830052	6934
F1		25kA	125	830039	6852	830053	9120

HSN Code: 8536

Image	Frame	Breaking capacity	Rating	3P	Unit Price (₹)	4P	Unit Price (₹)
		F1	36kA	16	830061	7316	830075
F1		36kA	25	830062	7316	830076	8366
F1		36kA	32	830063	7316	830077	8366
F1		36kA	40	830064	7316	830078	8366
F1		36kA	50	830065	7316	830079	8366
F1		36kA	63	830066	7316	830080	8366
F1		36kA	80	830067	7428	830081	8818
F1		36kA	100	830068	7428	830082	8818
F1		36kA	125	830069	10234	830083	10638

—optium™— **OPTIUM 1.0 (FIXED TM MCCB RANGE)**

HSN Code: 8536

	Frame	Breaking capacity	Rating	3P	Unit Price (₹)	4P	Unit Price (₹)
	F3	50kA	16	830125	8750	830145	10638
	F3	50kA	25	830126	8750	830146	10638
	F3	50kA	32	830127	8750	830147	10638
	F3	50kA	40	830128	8750	830148	10638
	F3	50kA	50	830129	8750	830149	10638
	F3	50kA	63	830130	8750	830150	10638
	F3	50kA	80	830131	9190	830151	10960
	F3	50kA	100	830132	9190	830152	10960
	F3	50kA	125	830133	10722	830153	13596

HSN Code: 8536

	Frame	Breaking capacity	Rating	3P	Unit Price (₹)	4P	Unit Price (₹)
	F2	16kA	160	830090	7202	830095	10450
	F2	16kA	200	830091	9324	830096	12138
	F2	16kA	250	830092	10288	830097	12820
	F2	25kA	160	830100	8526	830105	10724
	F2	25kA	200	830101	11792	830106	14266
	F2	25kA	250	830102	15216	830107	17886
	F2	36kA	160	830110	10740	830115	13162
	F2	36kA	200	830111	13756	830116	17380
	F2	36kA	250	830112	17956	830117	23612

HSN Code: 8536

	Frame	Breaking capacity	Rating	3P	Unit Price (₹)	4P	Unit Price (₹)
	F3	50kA	160	830134	11994	830154	16470
	F3	50kA	200	830135	14436	830155	20266
F3	50kA	250	830136	18566	830156	24666	

HSN Code: 8536

	Frame	Breaking capacity	Rating	3P	Unit Price (₹)	4P	Unit Price (₹)
	F4	36kA	315	830165	24244	830175	27658
	F4	36kA	400	830166	25622	830176	29228
	F4	36kA	500	830167	28672	830177	33178
F4	36kA	630	830168	30390	830178	34922	

HSN Code: 8536

	Frame	Breaking capacity	Rating	3P	Unit Price (₹)	4P	Unit Price (₹)
	F4	50kA	315	830185	24954	830195	29588
	F4	50kA	400	830186	27236	830196	31960
	F4	50kA	500	830187	29614	830197	34348
F4	50kA	630	830188	31392	830198	35592	

HSN Code: 8536

	Frame	Breaking capacity	Rating	3P	MRP	4P	MRP
F5	50kA	800	830200	40902	830201	52832	

—optium™— **OPTIUM 1.1 (FIXED TM MCCB RANGE)**

- Ics = 100% Icu as per IEC 60947-II
- Suitable for isolation
- Class II front face
- Fixed Overload & fixed short circuit setting

HSN Code: 8536

	Frame	Breaking capacity	Rating	3P	Unit Price (₹)	4P	Unit Price (₹)
		F1	16kA	32	840003	4780	840017
	F1	16kA	40	840004	4780	840018	6272
	F1	16kA	63	840006	4780	840020	6272
	F1	16kA	80	840007	4966	840021	6708
	F1	16kA	100	840008	4966	840022	6708
	F1	16kA	125	840009	6966	840023	9362
	F1	25kA	32	840033	5798	840047	7344
	F1	25kA	40	840034	5798	840048	7344
	F1	25kA	63	840036	5798	840050	7344
	F1	25kA	80	840037	6144	840051	7488
	F1	25kA	100	840038	6144	840052	7488
	F1	25kA	125	840039	7108	840053	10504
	F2	16kA	160	840090	7614	840095	11352
	F2	16kA	200	840091	9560	840096	12690
	F2	16kA	250	840092	10894	840097	14544
	F2	25kA	160	840100	8864	840105	11712
	F2	25kA	200	840101	12436	840106	14946
	F2	25kA	250	840102	16078	840107	20092

—optium™— **OPTIUM 2.0 (ADJUSTABLE THERMAL SETTING MCCB)**

- Conforms to IEC 60947-II
- Adjustable Overload Setting Ir = (0.8 to 1.0)In
- Ics = 100% Icu
- Class II front face
- Short Circuit setting fixed
- Suitable for isolation

HSN Code: 8536

	Frame	Breaking capacity	Rating	3P	Unit Price (₹)	4P	Unit Price (₹)
		F1	16kA	25	830222	4862	830236
	F1	16kA	32	830223	4862	830237	6494
	F1	16kA	40	830224	4862	830238	6494
	F1	16kA	50	830225	4862	830239	6494
	F1	16kA	63	830226	4862	830240	6494
	F1	16kA	80	830227	5272	830241	6982
	F1	16kA	100	830228	5272	830242	6982
	F1	16kA	125	830229	7198	830243	9730

HSN Code: 8536

	Frame	Breaking capacity	Rating	3P	Unit Price (₹)	4P	Unit Price (₹)
		F1	25kA	25	830252	6098	830266
	F1	25kA	32	830253	6098	830267	7678
	F1	25kA	40	830254	6098	830268	7678
	F1	25kA	50	830255	6098	830269	7678
	F1	25kA	63	830256	6098	830270	7678
	F1	25kA	80	830257	6398	830271	8054
	F1	25kA	100	830258	6398	830272	8054
	F1	25kA	125	830259	7404	830273	11020

HSN Code: 8536

	Frame	Breaking capacity	Rating	3P	Unit Price (₹)	4P	Unit Price (₹)
		F2	16kA	160	830280	7986	830285
	F2	16kA	200	830281	9952	830286	13176
	F2	16kA	250	830282	11520	830287	15566
	F2	25kA	160	830290	10108	830295	13260
	F2	25kA	200	830291	12938	830296	16692
	F2	25kA	250	830292	17296	830297	21632

—optium™— **OPTIUM 2.0 (ADJUSTABLE TM MCCB RANGE)**

- Ics =100% Icu as per IEC 60947-II
- Adjustable Overload Setting Ir =(0.8 to 1.0)xIn
- Class II front face
- Adjustable Short Circuit Setting Isd =(5 -10)xIn
- Suitable for isolation

HSN Code: 8536

	Frame	Breaking capacity	Rating	3P	Unit Price (₹)	4P	Unit Price (₹)
	F3	36kA	16	830305	8156	830325	11270
F3	36kA	25	830306	8156	830326	11270	
F3	36kA	32	830307	8156	830327	11270	
F3	36kA	40	830308	8156	830328	11270	
F3	36kA	50	830309	8156	830329	11270	
F3	36kA	63	830310	8156	830330	11270	
F3	36kA	80	830311	8317	830331	11602	
F3	36kA	100	830312	8317	830332	11602	
F3	36kA	125	830313	10782	830333	13000	

HSN Code: 8536

	Frame	Breaking capacity	Rating	3P	Unit Price (₹)	4P	Unit Price (₹)
	F3	50kA	16	830345	10982	830365	13126
F3	50kA	25	830346	10982	830366	13126	
F3	50kA	32	830347	10982	830367	13126	
F3	50kA	40	830348	10982	830368	13126	
F3	50kA	50	830349	10982	830369	13126	
F3	50kA	63	830350	10982	830370	13126	
F3	50kA	80	830351	11204	830371	13258	
F3	50kA	100	830352	11204	830372	13258	
F3	50kA	125	830353	12326	830373	15826	

HSN Code: 8536

	Frame	Breaking capacity	Rating	3P	Unit Price (₹)	4P	Unit Price (₹)
	F3	36kA	160	830314	13626	830334	16214
F3	36kA	200	830315	15280	830335	21156	
F3	36kA	250	830316	20072	830336	27706	

HSN Code: 8536

	Frame	Breaking capacity	Rating	3P	Unit Price (₹)	4P	Unit Price (₹)
	F3	50kA	160	830354	14122	830374	17810
F3	50kA	200	830355	16476	830375	22588	
F3	50kA	250	830356	23386	830376	29178	

HSN Code: 8536

	Frame	Breaking capacity	Rating	3P	Unit Price (₹)	4P	Unit Price (₹)
	F4	25kA	315	830385	21342	830387	26880
F4	25kA	400	830386	21852	830388	29326	
F4	36kA	315	830390	25648	830395	31238	
F4	36kA	400	830391	27286	830396	33634	
F4	36kA	500	830392	32114	830397	39432	
F4	36kA	630	830393	34550	830398	44170	
F4	50kA	315	830400	27386	830405	33828	
F4	50kA	400	830401	29228	830406	35520	
F4	50kA	500	830402	33480	830407	41646	
F4	50kA	630	830403	36196	830408	46202	

—optium™— **OPTIUM 2.0 (ADJUSTABLE TM MCCB RANGE)**

HSN Code: 8536

	Frame	Breaking capacity	Rating	3P	Unit Price (₹)	4P	Unit Price (₹)
	F5	36kA	800	830410	42212	830413	51762
F5	36kA	1000	830411	60794	830414	69540	
F5	36kA	1250	830412	70312	830415	83564	
F5	50kA	800	830416	43456	830419	61914	
F5	50kA	1000	830417	75576	830420	81044	
F5	50kA	1250	830418	83354	830421	93870	

—optium™— **OPTIUM 2.1 (ELECTRONIC / MICRO -PROCESSOR MCCB RANGE)**

- Ics =100% Icu as per IEC 60947-II
- Class II front face
- Suitable for isolation
- Adjustable Overload Setting $I_r = (0.4 - 1) \times I_n$
- Adjustable Short circuit Current Setting $I_{sd} = 1.5 - 10 \times I_r$

HSN Code: 8536

Frame	Breaking capacity	Rating	3P	Unit Price (₹)	4P	Unit Price (₹)
F3	36kA	40	830430	17370	830440	21876
F3	36kA	100	830431	17688	830441	22274
F3	36kA	160	830432	21620	830442	25992
F3	36kA	250	830433	27280	830443	33088
F3	50kA	40	830450	19422	830460	23322
F3	50kA	100	830451	20716	830461	24894
F3	50kA	160	830452	23570	830462	28822
F3	50kA	250	830453	31006	830463	37992

—optium™— **OPTIUM 2.1 (ELECTRONIC / MICRO -PROCESSOR MCCB RANGE)**

- Ics =100% Icu as per IEC 60947-II
- Class II front face
- Suitable for isolation
- Transparent cover for trip unit as standard
- Adjustable Neutral pole protection -N,N/2 & Off for 4 pole MCCB
- Innovative front indication LED's(Ready, Overload pre-alarm & Overload)
- Adjustable Overload Setting $I_r = (0.4 - 1) \times I_n$; $T_r = 3-30$ sec
- Adjustable Short circuit Current Setting $I_{sd} = (1.5 - 10) I_r$; $T_{sd} (I=K) = 0-500$ ms; $T_{sd} (I2t=K) = 0-500$ ms

HSN Code: 8536

	Frame	Breaking capacity	Rating	3P	Unit Price (₹)	4P	Unit Price (₹)
	F4	36kA	400	830510	32940	830512	43438
F4	36kA	630	830511	37116	830513	47158	
F4	50kA	400	830514	40722	830516	51788	
F4	50kA	630	830515	42172	830517	54672	

HSN Code: 8536

	Frame	Breaking capacity	Rating	3P	Unit Price (₹)	4P	Unit Price (₹)
	F5	36kA	800	830540	60808	830542	73734
F5	36kA	1250	830541	91440	830543	116492	
F5	50kA	800	830544	64918	830546	80988	
F5	50kA	1250	830545	111628	830547	154322	

—optium™— **OPTIUM 2.2 (WITH ELECTRONIC / MICRO PROCESSOR RELEASE)**

- Ics =100% Icu as per IEC 60947-II
- Class II front face
- Suitable for isolation
- Adjustable Overload Setting $I_r = (0.4 - 1) \times I_n$
- Adjustable Short circuit Current Setting $I_{sd} = (1.5 - 10) \times I_r$
- Ground fault Setting:- $I_g = (0.2 - 1) \times I_n$

HSN Code: 8536

Frame	Breaking capacity	Rating	3P	Unit Price (₹)	4P	Unit Price (₹)
F3	36kA	40	830470	20646	830480	25806
F3	36kA	100	830471	21202	830481	26496
F3	36kA	160	830472	23816	830482	29510
F3	36kA	250	830473	30434	830483	37450
F3	50kA	40	830490	22494	830500	27218
F3	50kA	100	830491	23098	830501	27576
F3	50kA	160	830492	26462	830502	32130
F3	50kA	250	830493	34400	830503	41424

—optium™— **OPTIUM 2.2 (ELECTRONIC / MICRO -PROCESSOR MCCB RANGE)**

- Ics =100% Icu as per IEC 60947-II
- Class II front face
- Suitable for isolation
- Adjustable Neutral pole protection -N,N/2 & Off for 4 pole MCCB
- Innovative front indication LED's(Ready, Overload pre-alarm & Overload)
- Adjustable Overload Setting Ir = 0.4 - 1 x In ; Tr = 3-30 sec
- Adjustable Short circuit Current Setting Isd = 1.5 - 10 Ir ; Tsd (I=K) = 0-500 ms; Tsd (I2t=K) = 0-500 ms
- Ground fault Setting:- Ig = (0.2 - 1) x In ; Tg = (0.1 - 1) s

HSN Code: 8536

	Frame	Breaking capacity	Rating	3P	Unit Price (₹)	4P	Unit Price (₹)
	F4	36kA	400	830520	43802	830522	51934
	F4	36kA	630	830521	50058	830523	63822
	F4	50kA	400	830524	49136	830526	56574
	F4	50kA	630	830525	55538	830527	70872

HSN Code: 8536

	Frame	Breaking capacity	Rating	3P	Unit Price (₹)	4P	Unit Price (₹)
	F5	36kA	800	830550	76158	830552	96202
	F5	36kA	1250	830551	101548	830553	132946
	F5	50kA	800	830554	90858	830556	111796
	F5	50kA	1250	830555	118914	830557	161978

—optium™— **ACCESSORIES**

HSN Code: 8538

	Product	Frame	Cat Ref.	Unit Price (₹)
	Auxiliary contact	F1 F2 F3	830691	1118
	Alarm Contact	F1 F2 F3	830692	1118
	Auxiliary contact / Alarm Contact	F4-F5	830693	1466
	Auxiliary contact / Alarm Contact	F1 F2 F3	830694	1674

HSN Code: 8538

	Product	Frame	Cat Ref.	Unit Price (₹)
	"Shunt trip 24 V AC/DC"	F1 F2 F3	830602	1266
	"Shunt trip 110 V AC/DC"	F1 F2 F3	830603	1266
	"Shunt trip 230 V AC/DC"	F1 F2 F3	830604	1354
	"Shunt trip 415 V AC/DC"	F1 F2 F3	830605	1354
	"Shunt trip 24 V AC/DC"	F4 F5	830642	2488
	"Shunt trip 110 V AC/DC"	F4 F5	830643	2488
	"Shunt trip 230 V AC/DC"	F4 F5	830644	2488
	"Shunt trip 415 V AC/DC"	F4 F5	830645	2488

HSN Code: 8538

	Product	Frame	Cat Ref.	Unit Price (₹)
	"Undervoltage 24 V DC"	F1 F2 F3	830606	2076
	"Undervoltage 110V AC"	F1 F2 F3	830607	2076
	"Undervoltage 230V AC"	F1 F2 F3	830608	2076
	"Undervoltage 415V AC"	F1 F2 F3	830609	2076
	"Undervoltage 24 V DC"	F4 F5	830646	2210
	"Undervoltage 110V AC"	F4 F5	830647	2210
	"Undervoltage 230V AC"	F4 F5	830648	2210
	"Undervoltage 415V AC"	F4 F5	830649	2210

—optium™— **ACCESSORIES**

HSN Code: 8538

	Product	Frame	Cat Ref.	Unit Price (₹)
	Rotary Handle Direct	F1	830611	1590
	Rotary Handle vary-Depth	F1	830612	1590
	Rotary Handle Direct	F2 F3	830626	1868
	Rotary Handle vary-Depth	F2 F3	830627	1868
	Rotary Handle Direct	F4	830651	2210
	Rotary Handle vary-Depth	F4	830652	2210
	Rotary Handle Direct	F5	830671	4330
	Rotary Handle vary-Depth	F5	830672	4330

HSN Code: 8538

	Product	Frame	Cat Ref.	Unit Price (₹)
	Ronis lock Direct RH	F1 F2 F3	830613	1740
	Ronis lock Vary-Depth RH	F1 F2 F3	830614	1740
	Ronis lock Vary-Depth RH	F4	830653	2350

HSN Code: 8538

	Product	Frame	Cat Ref.	Unit Price (₹)
	Padlock Off position	F1 F2 F3	830615	2372
	Padlock Off position	F4	830654	2372
	Padlock Off position	F5	830674	2372

HSN Code: 8538

	Product	Frame	Cat Ref.	Unit Price (₹)
	Phase insulators 3P	F1 F2	830616	POR
	Phase insulators 3P	F3	830628	POR
	Phase insulators 3P	F4	830655	POR
	Phase insulators 3P	F5	830675	POR
	Phase insulators 4P	F1 F2	830617	POR
	Phase insulators 4P	F3	830629	POR
	Phase insulators 4P	F4	830656	POR
	Phase insulators 4P	F5	830676	POR

** POR - Price on Request.

HSN Code: 8538

	Product	Frame	Cat Ref.	Unit Price (₹)
	Terminal cover 3P	F4	830657	POR
	Terminal cover 3P	F5	830677	POR
	Terminal cover 4P	F4	830658	POR
	Terminal cover 4P	F5	830678	POR
	Terminal shield 3P	F5	830679	POR
	Terminal shield 4P	F5	830680	POR

** POR - Price on Request.

—optium™— **ACCESSORIES**

HSN Code: 8538

	Product	Frame	Cat Ref.	Unit Price (₹)
	Spreaders 3P	F1	830618	430
	Spreaders 4P	F1	830619	628
	Spreaders 3P	F2 F3	830632	1112
	Spreaders 4P	F2 F3	830633	2222
	Spreaders 3P	F4	830659	3522
	Spreaders 4P	F4	830660	5136
	Spreaders 3P 800/1000A	F5	830681	9096
	Spreaders 4P 800/1000A	F5	830682	13802
	Spreaders 3P 1250A	F5	830685	9460
	Spreaders 4P 1250A	F5	830686	13944

HSN Code: 8538

	Product	Frame	Cat Ref.	Unit Price (₹)
	Cages 3P upto 50A	F1	830620	POR
	Cages 4P upto 50A	F1	830621	POR
	Cages 3P 63 to 100A	F1	830622	POR
	Cages 4P 63 to 100A	F1	830623	POR
	Cages 3P 125A	F1	830624	POR
	Cages 4P 125A	F1	830625	POR
	Cages 3P	F2	830630	POR
	Cages 4P	F2	830631	POR
	Cages 3P	F3	830634	POR
	Cages 4P	F3	830635	POR
	Cages 3P	F4	830661	POR
	Cages 4P	F4	830662	POR
	Cages 3P	F5	830683	POR
	Cages 4P	F5	830684	POR

** POR - Price on Request.

READY TO USE-SAFE- RELIABLE SUB MAIN DISTRIBUTION BOARD.



— optipro[™] SMDB —



Highly reliable & tested
solution as per IEC 61439



Easy to install



3 frame Sizes: SMDB250,
SMDB400 & SMDB630



*IP43 degree of
protection

Optipro SMDB 250 (Single Door) - Main enclosure (with a provision to mount TP MCCBs as an outgoing*) HSN Code: 8536

- Tested as er IEC 61439-2 • Degree of protection IP-30 in Single door & IP-43 in Double door
- 3 Frame sizes - SMDB250, SMDB400, SMDB630 • wide range- 4W, 6W, 8W &12W

Item Description	Type	Cat Ref.	Unit Price (₹)
SMDB250 4W SD ME Optium F2-I/c & TP F1 O/G	SD	812100	42126
SMDB250 6W SD ME Optium F2-I/c & TP F1 O/G	SD	812101	45225
SMDB250 8W SD ME Optium F2-I/c & TP F1 O/G	SD	812102	51940
SMDB250 12W SD ME Optium F2-I/c & TP F1 O/G	SD	812103	61387
SMDB250 4W SD ME Optium F3-I/c & TP F1 O/G	SD	812110	45775
SMDB250 6W SD ME Optium F3-I/c & TP F1 O/G	SD	812111	49140
SMDB250 8W SD ME Optium F3-I/c & TP F1 O/G	SD	812112	56438
SMDB250 12W SD ME Optium F3-I/c & TP F1 O/G	SD	812113	66734

Optipro SMDB 400 (Single Door) - Main enclosure (with a provision to mount TP MCCBs as an outgoing*) HSN Code: 8536

Item Description	Type	Cat Ref.	Unit Price (₹)
SMDB400 4W SD ME Optium F4-I/c & TP F1 O/G	SD	812120	47100
SMDB400 6W SD ME Optium F4-I/c & TP F1 O/G	SD	812121	50539
SMDB400 8W SD ME Optium F4-I/c & TP F1 O/G	SD	812122	58212
SMDB400 12W SD ME Optium F4-I/c & TP F1 O/G	SD	812123	68796
SMDB400 8W SD ME Optium F4-I/c & TP F1-6 & F2-2 O/G	SD	812124	POR
SMDB400 12W SD ME Optium F4-I/c & TP F1-8 & F2-4 O/G	SD	812125	POR
SMDB400 12W SD ME Optium F4-I/c & TP F1-10 & F2-2 O/G	SD	812126	POR

Optipro SMDB 630 (Single Door) - Main enclosure (with a provision to mount TP MCCBs as an outgoing*) HSN Code: 8536

Item Description	Type	Cat Ref.	Unit Price (₹)
SMDB630 4W SD ME Optium F4-I/c & TP F1 O/G	SD	812136	70649
SMDB630 6W SD ME Optium F4-I/c & TP F1 O/G	SD	812137	73294
SMDB630 8W SD ME Optium F4-I/c & TP F1 O/G	SD	812138	84408
SMDB630 12W SD ME Optium F4-I/c & TP F1 O/G	SD	812139	99754
SMDB630 8W SD ME Optium F4-I/c & TP F1-6 & F2-2 O/G	SD	812140	84408
SMDB630 12W SD ME Optium F4-I/c & TP F1-8 & F2-4 O/G	SD	812141	POR
SMDB630 12W SD ME Optium F4-I/c & TP F1-10 & F2-2 O/G	SD	812142	99754

Optipro SMDB 250 (Single Door) - Main enclosure (with a provision to mount FP MCCBs as an outgoing*) HSN Code: 8536

Item Description	Type	Cat Ref.	Unit Price (₹)
SMDB250 4W SD ME Optium F2-I/c & FP F1 O/G	SD	812105	46327
SMDB250 6W SD ME Optium F2-I/c & FP F1 O/G	SD	812106	49725
SMDB250 8W SD ME Optium F2-I/c & FP F1 O/G	SD	812107	57154
SMDB250 12W SD ME Optium F2-I/c & FP F1 O/G	SD	812108	67738
SMDB250 4W SD ME Optium F3-I/c & FP F1 O/G	SD	812115	50351
SMDB250 6W SD ME Optium F3-I/c & FP F1 O/G	SD	812116	54089
SMDB250 8W SD ME Optium F3-I/c & FP F1 O/G	SD	812117	62105
SMDB250 12W SD ME Optium F3-I/c & FP F1 O/G	SD	812118	73614

Optipro SMDB 400 (Single Door) - Main enclosure (with a provision to mount FP MCCBs as an outgoing*) HSN Code: 8536

Item Description	Type	Cat Ref.	Unit Price (₹)
SMDB400 4W SD ME Optium F4-I/c & FP F1 O/G	SD	812128	51862
SMDB400 6W SD ME Optium F4-I/c & FP F1 O/G	SD	812129	55831
SMDB400 8W SD ME Optium F4-I/c & FP F1 O/G	SD	812130	64034
SMDB400 12W SD ME Optium F4-I/c & FP F1 O/G	SD	812131	75941
SMDB400 8W SD ME Optium F4-I/c & FP F1-6 & F2-2 O/G	SD	812132	POR
SMDB400 12W SD ME Optium F4-I/c & FP F1-8 & F2-4 O/G	SD	812133	POR
SMDB400 12W SD ME Optium F4-I/c & FP F1-10 & F2-2 O/G	SD	812134	POR

Optipro SMDB 630 (Single Door) - Main enclosure (with a provision to mount FP MCCBs as an outgoing*) HSN Code: 8536

Item Description	Type	Cat Ref.	Unit Price (₹)
SMDB630 4W SD ME Optium F4-I/c & FP F1 O/G	SD	812144	77794
SMDB630 6W SD ME Optium F4-I/c & FP F1 O/G	SD	812145	80969
SMDB630 8W SD ME Optium F4-I/c & FP F1 O/G	SD	812146	92875
SMDB630 12W SD ME Optium F4-I/c & FP F1 O/G	SD	812147	110074
SMDB630 8W SD ME Optium F4-I/c & FP F1-6 & F2-2 O/G	SD	812148	92875
SMDB630 12W SD ME Optium F4-I/c & FP F1-8 & F2-4 O/G	SD	812149	POR
SMDB630 12W SD ME Optium F4-I/c & FP F1-10 & F2-2 O/G	SD	812150	110074

Optipro SMDB 250 (Double Door) - Main enclosure (with a provision to mount TP MCCBs as an outgoing*)

HSN Code: 8536

	Item Description	Type	Cat Ref.	Unit Price (₹)
	SMDB250 4W DD ME Optium F2-I/c & TP F1 O/G	DD	812181	49900
	SMDB250 6W DD ME Optium F2-I/c & TP F1 O/G	DD	812182	53791
	SMDB250 8W DD ME Optium F2-I/c & TP F1 O/G	DD	812183	61841
	SMDB250 12W DD ME Optium F2-I/c & TP F1 O/G	DD	812184	72898
	SMDB250 4W DD ME Optium F3-I/c & TP F1 O/G	DD	812191	52204
	SMDB250 6W DD ME Optium F3-I/c & TP F1 O/G	DD	812192	56230
	SMDB250 8W DD ME Optium F3-I/c & TP F1 O/G	DD	812193	64673
	SMDB250 12W DD ME Optium F3-I/c & TP F1 O/G	DD	812194	76205

Optipro SMDB 400 (Double Door) - Main enclosure (with a provision to mount TP MCCBs as an outgoing*)

HSN Code: 8536

	Item Description	Type	Cat Ref.	Unit Price (₹)
	SMDB400 4W DD ME Optium F4-I/c & TP F1 O/G	DD	812201	53714
	SMDB400 6W DD ME Optium F4-I/c & TP F1 O/G	DD	812202	57948
	SMDB400 8W DD ME Optium F4-I/c & TP F1 O/G	DD	812203	66679
	SMDB400 12W DD ME Optium F4-I/c & TP F1 O/G	DD	812204	78586
	SMDB400 8W DD ME Optium F4-I/c & TP F1-6 & F2-2 O/G	DD	812205	POR
	SMDB400 12W DD ME Optium F4-I/c & TP F1-8 & F2-4 O/G	DD	812206	POR
	SMDB400 12W DD ME Optium F4-I/c & TP F1-10 & F2-2 O/G	DD	812207	POR

Optipro SMDB 630 (Double Door) - Main enclosure (with a provision to mount TP MCCBs as an outgoing*)

HSN Code: 8536

	Item Description	Type	Cat Ref.	Unit Price (₹)
	SMDB630 4W DD ME Optium F4-I/c & TP F1 O/G	DD	812217	80702
	SMDB630 6W DD ME Optium F4-I/c & TP F1 O/G	DD	812218	84144
	SMDB630 8W DD ME Optium F4-I/c & TP F1 O/G	DD	812219	96578
	SMDB630 12W DD ME Optium F4-I/c & TP F1 O/G	DD	812220	114043
	SMDB630 8W DD ME Optium F4-I/c & TP F1-6 & F2-2 O/G	DD	812221	96578
	SMDB630 12W DD ME Optium F4-I/c & TP F1-8 & F2-4 O/G	DD	812222	POR
	SMDB630 12W DD ME Optium F4-I/c & TP F1-10 & F2-2 O/G	DD	812223	114043

Optipro SMDB 250 (Double Door) - Main enclosure (with a provision to mount FP MCCBs as an outgoing*)

HSN Code: 8536

	Item Description	Type	Cat Ref.	Unit Price (₹)
	SMDB250 4W DD ME Optium F2-I/c & FP F1 O/G	DD	812186	54906
	SMDB250 6W DD ME Optium F2-I/c & FP F1 O/G	DD	812187	59159
	SMDB250 8W DD ME Optium F2-I/c & FP F1 O/G	DD	812188	68026
	SMDB250 12W DD ME Optium F2-I/c & FP F1 O/G	DD	812189	80362
	SMDB250 4W DD ME Optium F3-I/c & FP F1 O/G	DD	812196	57472
	SMDB250 6W DD ME Optium F3-I/c & FP F1 O/G	DD	812197	61861
	SMDB250 8W DD ME Optium F3-I/c & FP F1 O/G	DD	812198	71122
	SMDB250 12W DD ME Optium F3-I/c & FP F1 O/G	DD	812199	83989

Optipro SMDB 400 (Double Door) - Main enclosure (with a provision to mount FP MCCBs as an outgoing*)

HSN Code: 8536

	Item Description	Type	Cat Ref.	Unit Price (₹)
	SMDB400 4W DD ME Optium F4-I/c & FP F1 O/G	DD	812209	59270
	SMDB400 6W DD ME Optium F4-I/c & FP F1 O/G	DD	812210	63768
	SMDB400 8W DD ME Optium F4-I/c & FP F1 O/G	DD	812211	73294
	SMDB400 12W DD ME Optium F4-I/c & FP F1 O/G	DD	812212	86525
	SMDB400 8W DD ME Optium F4-I/c & FP F1-6 & F2-2 O/G	DD	812213	POR
	SMDB400 12W DD ME Optium F4-I/c & FP F1-8 & F2-4 O/G	DD	812214	POR
	SMDB400 12W DD ME Optium F4-I/c & FP F1-10 & F2-2 O/G	DD	812215	POR

Optipro SMDB 630 (Double Door) - Main enclosure (with a provision to mount FP MCCBs as an outgoing*)

HSN Code: 8536

	Item Description	Type	Cat Ref.	Unit Price (₹)
	SMDB630 4W DD ME Optium F4-I/c & FP F1 O/G	DD	812225	88906
	SMDB630 6W DD ME Optium F4-I/c & FP F1 O/G	DD	812226	92345
	SMDB630 8W DD ME Optium F4-I/c & FP F1 O/G	DD	812227	106370
	SMDB630 12W DD ME Optium F4-I/c & FP F1 O/G	DD	812228	125422
	SMDB630 8W DD ME Optium F4-I/c & FP F1-6 & F2-2 O/G	DD	812229	106370
	SMDB630 12W DD ME Optium F4-I/c & FP F1-8 & F2-4 O/G	DD	812230	POR
	SMDB630 12W DD ME Optium F4-I/c & FP F1-10 & F2-2 O/G	DD	812231	125422

Optipro SMDB - Bottom cable Unit (Single Door)

HSN Code: 8536

	Item Description	Type	Cat Ref.	Unit Price (₹)
	Bottom Cable Unit(for SD SMDB's with F1 O/G only)	SD	812152	5050
Bottom Cable Unit(for SD SMDB's with F1 & F2 O/G)	SD	812153	5691	

Optipro SMDB 250 - Cable Alley Unit (Single Door)

HSN Code: 8536

	Item Description	Type	Cat Ref.	Unit Price (₹)
	SMDB250 Cable Alley-4W SD	SD	812154	11961
	SMDB250 Cable Alley-6W SD	SD	812155	14102
	SMDB250 Cable Alley-8W SD	SD	812156	15235
	SMDB250 Cable Alley-12W SD	SD	812157	17179

Optipro SMDB 400/630 - Cable Alley (Single Door)

HSN Code: 8536

	Item Description	Type	Cat Ref.	Unit Price (₹)
	SMDB400/630 Cable Alley-4W SD	SD	812159	16670
	SMDB400/630 Cable Alley-6W SD	SD	812160	18368
	SMDB400/630 Cable Alley-8W SD	SD	812161	19867
	SMDB400/630 Cable Alley-12W SD	SD	812162	21775
	SMDB400/630 Cable Alley-8W SD	SD	812163	19867
	SMDB400/630 Cable Alley-12W SD	SD	812164	21775
	SMDB400/630 Cable Alley-12W SD	SD	812165	21775
	Metering Unit(for SD SMDB's with F1 O/G only)- with Ammeter,Voltmeter & Phase Indicators(3nos.)	SD	812167	16725
	Metering Unit (for SD SMDB's with F1 & F2 O/G) - with Ammeter,Voltmeter & Phase Indicators(3nos.)	SD	812168	18128
	Metering Unit(for SD SMDB's with F1 O/G only)- with Multifunction meter, Buzzer & Phase Indicators(3nos.)	SD	812169	20904
	Metering Unit (for SD SMDB's with F1 & F2 O/G) - with Multifunction meter, Buzzer & Phase Indicators(3nos.)	SD	812170	22680
	Corner Unit-SD	SD	812171	2008

Optipro SMDB - Bottom cable Unit (Double Door)

HSN Code: 8536

	Item Description	Type	Cat Ref.	Unit Price (₹)
	Bottom Cable Unit(for DD SMDB's with F1 O/G only)	DD	812233	5667
Bottom Cable Unit(for DD SMDB's with F1 & F2 O/G)	DD	812234	6375	

Optipro SMDB 250- Cable Alley Unit (Double Door)

HSN Code: 8536

	Item Description	Type	Cat Ref.	Unit Price (₹)
	SMDB250 Cable Alley-6W DD	DD	812236	15799
	SMDB250 Cable Alley-8W DD	DD	812237	17070
	SMDB250 Cable Alley-12W DD	DD	812238	19241

Optipro SMDB 400/630- Cable Alley Unit (Double Door)

HSN Code: 8536

	Item Description	Type	Cat Ref.	Unit Price (₹)
	SMDB400/630 Cable Alley-4W DD	DD	812240	18678
	SMDB400/630 Cable Alley-6W DD	DD	812241	20583
	SMDB400/630 Cable Alley-8W DD	DD	812242	22251
	SMDB400/630 Cable Alley-12W DD	DD	812243	24398
	SMDB400/630 Cable Alley-8W DD	DD	812244	22251
	SMDB400/630 Cable Alley-12W DD	DD	812245	24398
	SMDB400/630 Cable Alley-12W DD	DD	812246	24398
	Metering Unit(for DD SMDB's with F1 O/G only)- with Ammeter,Voltmeter & Phase Indicators(3nos.)	DD	812248	21753
	Metering Unit (for DD SMDB's with F1 & F2 O/G) - with Ammeter,Voltmeter & Phase Indicators(3nos.)	DD	812249	23549
	Metering Unit(for DD SMDB's with F1 O/G only)- with Multifunction meter, Buzzer & Phase Indicators(3nos.)	DD	812250	27178
	Metering Unit (for DD SMDB's with F1 & F2 O/G) - with Multifunction meter, Buzzer & Phase Indicators(3nos.)	DD	812251	29426
	Corner Unit-DD	DD	812252	2008

SWITCH ON TO NEW RANGE OF EFFICIENT

SWITCH DISCONNECTOR AND TRANSFER SWITCHING EQUIPMENT



Modular

32, 40, 63A



SD



TSE

Panel Mounted

Frame 1- 100, 125, 160A Frame 2- 200, 250, 320A

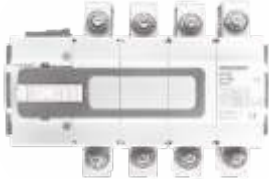

SD



TSE



APPLICATIONS



Features

1. Quick and Easy Installation
2. Operational Voltage upto 550 V
3. High short time withstand upto 12.5kA for 1 sec
4. High Mechanical and Electrical endurance
5. Extra safety with add on accessories



UNCOMPROMISED SAFETY WITH ADD ON ACCESSORIES



DIN FRAME

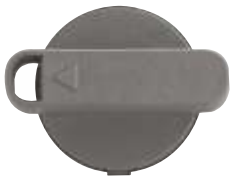

Direct Handle



Insulated Shorting Links



Auxillary Contact



Vari Depth Rotary Handle



POWER FRAME



Inter Source Barrier



Phase Barrier



Spreader



Auxillary Contact



Vari Depth Rotary Handle

— optinova™ —

Switch Disconnecter



Transfer Switching Equipment



				Din Frame			Power Frame-1				Power Frame-2	
Performance				IndoAsian OptiNova-SD								
General	Frame	Ith	A	63			160				320	
	Rated currents			32	40	63	63	100	125	160	200	250
	Poles	4			4				4			
Electrical	Rated insulation voltage	Uj	V	690			1000				1000	
	Rated Impulse Withstand Voltage	Uimp	kV	8			8				12	
	Rated frequency	50/60			50/60				50/60			
	Short time withstand current @ rated time(s)	t(s)	Icw for 1s	1.5kA			4kA		5kA		10kA	12.5kA

— optinova™ — **4P SWITCH DISCONNECTOR / TRANSFER SWITCHING EQUIPEMENT - DIN FRAME HSN Code: 8536**

Rated Current	Switch Disconnecter		Transfer Switching Equipment TSE (On Load ChangeOver)	
	Cat Ref.	Unit Price (₹)	Cat Ref.	Unit Price (₹)
32A	824006	2164	824106	3966
40A	824007	2286	824107	4430
63A	824008	2708	824108	4944

— optinova™ — **4P SWITCH DISCONNECTOR / TRANSFER SWITCHING EQUIPEMENT - POWER FRAME HSN Code: 8536**

Rated Current	Switch Disconnecter		Transfer Switching Equipment TSE (On Load ChangeOver)		Transfer Switching Equipment TSE (On Load ChangeOver) with Enclosure	
	Cat Ref.	Unit Price (₹)	Cat Ref.	Unit Price (₹)	Cat Ref.	Unit Price (₹)
63A	824082	3672	824182	5764	824192	8384
100A	824083	5120	824183	7172	824193	10962
125A	824084	5532	824184	10758	824194	15402
160A	824085	7010	824185	11992	824195	16932
200A	824086	8772	824186	14332	824196	19686
250A	824087	11016	824187	20502	824197	26214
320A	824088	12228	824188	21832	824198	28254

— optinova™ — **ACCESSORIES - DIN FRAME HSN Code: 8538**

Product	Cat Ref.	Unit Price (₹)
Shorting links 63A for TSE	824201	754
Auxiliary contact Simultaneous (1 NO + 1 NC)	824208	398
Handle Vary Depth KIT IP54	824209	1112
SD Direct Handle	824215	888
TSE Direct Handle	824217	888

— optinova™ — **ACCESSORIES - POWER FRAME HSN Code: 8538**

Product	Frame 1- 160A		Frame 2- 320A	
	Cat Ref.	Unit Price (₹)	Cat Ref.	Unit Price (₹)
Aux contact Simultaneous (4 NO + 4 NC)	824245	1112	824245	1112
Shorting Link for TSE	824249	2132	824241	3192
Phase Barriers	824251	174	824243	224
Inter source barrier for TSE	824252	224	824239	358
Spreader terminals (one side only)	824254	868	824238	1734
Handle Direct	824230	928	824230	928
Handle Vary Depth	824231	1326	824231	1326

HRC FUSE LINKS & BASES

BOLTED TYPE (BS) BREAKING CAPACITY ≥ 80kA 500 V AC 50 Hz.

HSN Code: 8536

	Rating	Type	Cat Ref.	Tag Type	Unit Price (₹)	Unit/Carton
		2, 4, 6, 8, 10, 16A	FGN	IEFGN***	Offset	92
	20, 25, 32A	FGN	IEFGN***	Offset	102	20
	2, 4, 6, 10, 16, 20, 25, 32A	FSA	IEFSA***	Offset	136	10
	35, 40, 50, 63A	FSS	IEFSS***	Offset	154	10
	50, 63, 80, 100, 125, 160A	FSDCP	IEDCP***	Offset	326	10
	100, 125, 160, 200, 250A	FSFP	IESFP***	Offset	468	3
	50, 63, 80, 100, 125A	FSDC	IESDC***	Central	326	10
	100, 125, 160, 200, 250A	FSF	IEFSF***	Central	478	3
	225, 250, 300, 315, 320A	FSK	IEFSK***	Central	692	3
	355, 400A	FMF	IEFMF***	Central	1336	3
	355, 400, 450, 500, 560, 600, 630A	FTS	IEFTS***	Central	1542	1
	355, 400, 450, 500, 560A	FTM	IEFTM***	2 Central	1990	1
	600, 630A	FTM	IEFTM***	2 Central	2736	1

DIN TYPE BREAKING CAPACITY ≥ 80kA 500 V AC 50 Hz.

HSN Code: 8536

	Rating Amps	Type	Cat Ref.	Unit Price (₹)	Unit/Carton
		2, 4, 6, 10, 16, 20, 25, 32, 50, 63A	Size 000	IWS00***	408
	2, 4, 6, 10, 16, 20, 25, 32, 36, 40, 50, 63A	Size 00	IW000***	434	6
	80, 100A		IW000***	434	6
	125, 160A		IW000***	434	6
	32, 36, 50, 63, 80, 100, 125, 160, 200A	Size 01	IW001***	794	3
	250A		IW001***	794	3
	100, 125, 160, 200, 250, 315A	Size 02	IW002***	1164	3
	400A		IW002***	1164	3
	315, 355, 400, 425A	Size 03	IW003***	1600	3
	500, 630A		IW003***	1600	3

* Note HRC fuses with SC breaking capacity 120kA are available on request.

CYLINDRICAL TYPE (IFRH) BREAKING CAPACITY > 80kA 415 V AC.

HSN Code: 8536

	Rating	Cat Ref.	Unit Price (₹)
		2 to 25A	IFRHO***
	32 to 40A	IFRHO***	180
	50A	IFRH0050	334
	63A	IFRH0063	344
	Fuse Holder Fr type (2 to 63A)	IFR00***	322

FUSE FITTINGS FOR BOLTED (BS) TYPE

HSN Code: 8536

	Rating	Front Connection	Unit Price (₹)	Back Busbar Connection	Unit Price (₹)	Unit/Carton
		20A	BFFC 0020	194	BFBC 0020	210
	32A	BFFC 0032	342	BFBC 0032	354	10
	63A	BFFC 0063	492	BFBC 0063	518	5
	100A	BFFC 0100	1264	BFBC 0100	1302	3
	20A (Stud Type)			BFCS 020	282	1

FUSE BASES FOR DIN TYPE HRC FUSE LINKS

HSN Code: 8536

	Rating Amps	Suitable for	Cat Ref.	Unit Price (₹)	Unit/Carton
		6-160A	Size - 00	IWFB0***	558
	32-250A	Size - 1	IWFB1***	1062	2
	100-400A	Size - 2	IWFB2***	1588	2
	315-630A	Size - 3	IWFB3***	2014	2

SWITCH DISCONNECTOR FUSES

HSN Code: 8536

Rated Current	Type	IN OPEN EXECUTION*		IN SHEET STEEL ENCLOSURE		Recommended HRC Fuse Indo Asian Make
		Cat Ref.	Unit Price (₹)	Cat Ref.	Unit Price (₹)	
32A BS	TPN	INO1A032	2096	INS1A032	4276	FSA
63A BS	TPN	INO1A063	2900	INS1A063	5448	FSS
100A BS	TPN	INO1A100	6374	INS1A100	8916	FSDCP
125A BS	TPN	INO1A125	7152	INS1A125	10686	FSDCP
160A BS	TPN	INO1A160	8656	INS1A160	11932	FSDCP
200A BS	TPN	INO1A200	10772	INS1A200	13880	FSF
250A BS	TPN	INO1A250	12158	INS1A250	16048	FSF
315A BS	TPN	INO1A315	15580	INS1A315	20036	FSK
400A BS	TPN	INO1A400	19338	INS1A400	23916	FMF
32A BS	TPSN	INO1B032	2664	INS1B032	4510	FSA
63A BS	TPSN	INO1B063	3382	INS1B063	5336	FSS
100A BS	TPSN	INO1B100	7836	INS1B100	9984	FSDCP
125A BS	TPSN	INO1B125	8582	INS1B125	10686	FSDCP
160A BS	TPSN	INO1B160	10734	INS1B160	13810	FSDCP
200A BS	TPSN	INO1B200	12226	INS1B200	15282	FSF
250A BS	TPSN	INO1B250	13330	INS1B250	17158	FSF
315A BS	TPSN	INO1B315	18862	INS1B315	23966	FSK
400A BS	TPSN	INO1B400	22314	INS1B400	24928	FMF

* Price Does Not Include HRC Fuse

HSN Code: 8536

Rated Current	Type	IN OPEN EXECUTION*		IN SHEET STEEL ENCLOSURE		Recommended HRC Fuse Indo Asian Make
		Cat Ref.	Unit Price (₹)	Cat Ref.	Unit Price (₹)	
32A DIN	TPN	IN1OA032	2202	IN1SA032	4070	Size 000
63A DIN	TPN	IN1OA063	3054	IN1SA063	5172	Size 000
100A DIN	TPN	IN1OA100	6534	IN1SA100	8818	Size 00
125A DIN	TPN	IN1OA125	7464	IN1SA125	10656	Size 00
160A DIN	TPN	IN1OA160	8982	IN1SA160	11706	Size 00
200A DIN	TPN	IN1OA200	11216	IN1SA200	13324	Size 01
250A DIN	TPN	IN1OA250	12564	IN1SA250	16038	Size 01
315A DIN	TPN	IN1OA315	16140	IN1SA315	19964	Size 02
400A DIN	TPN	IN1OA400	19896	IN1SA400	23664	Size 02
630A DIN	TPN	IN1OA630	31338	IN1SA630	33750	Size 03
800A DIN	TPN	IN1OA800	38210	IN1SA800	47776	Size 03
32A DIN	TPSN	IN1OB032	3120	IN1SB032	4188	Size 000
63A DIN	TPSN	IN1OB063	3598	IN1SB063	4522	Size 000
100A DIN	TPSN	IN1OB100	8060	IN1SB100	9020	Size 00
125A DIN	TPSN	IN1OB125	8932	IN1SB125	9710	Size 00
160A DIN	TPSN	IN1OB160	10466	IN1SB160	12982	Size 00
200A DIN	TPSN	IN1OB200	12162	IN1SB200	13694	Size 01
250A DIN	TPSN	IN1OB250	13928	IN1SB250	15688	Size 01
315A DIN	TPSN	IN1OB315	18642	IN1SB315	21348	Size 02
400A DIN	TPSN	IN1OB400	21666	IN1SB400	26656	Size 02
630A DIN	TPSN	IN1OB630	34782	IN1SB630	36460	Size 03
800A DIN	TPSN	IN1OB800	40218	IN1SB800	52522	Size 03

* Price Does Not Include HRC Fuse

SWITCH DISCONNECTOR 4 POLE

HSN Code: 8536

Rated Current	IN OPEN EXECUTION*		IN SHEET STEEL ENCLOSURE	
	Cat Ref.	Unit Price (₹)	Cat Ref.	Unit Price (₹)
400A	IN1SD400	15856	IN3ED400	25080
630A	IN1SD630	22004	IN4ED630	36588
800A	IN1SD800	26206	IN4ED800	42380

*Prices of 3 Pole SD is available on Request.

**Ambidex CHANGEOVER SWITCHES
ON-LOAD CHANGEOVER SWITCHES 4 POLE**

HSN Code: 8536

Rated Current	IN OPEN EXECUTION		IN SHEET STEEL ENCLOSURE	
	Cat Ref.	Unit Price (₹)	Cat Ref.	Unit Price (₹)
400A	ICAE0400	34340	ICAS0400	53944
630A	ICAE0630	40454	ICAS0630	57806
800A	ITAE0800	56694	ITAS0800	85098
1000A	ITAE1000	102558	ITAS1000	142624
1250A	ITAE1250	137638	ITAS1250	196900
1600A	ITAE1600	158046	ITAS1600	261262
2000A	ITAE2000	231116	ITAS2000	321902
2500A	ITAE2500	317966	ITAS2500	426984
3150A	ITAE3150	326784	ITAS3150	554292



HSN Code: 8536

ACCESSORIES FOR AMBIDEX CHANGEOVER SWITCHES	Cat Ref.	Unit Price (₹)
Auxiliary Switch 200A-630A (1NO + 1NC)	ICA00AUX	236
Spreader Links for Frame00 - 1 set (4 links)	ICA00SPL	372

ON-LOAD SWITCH FUSE CHANGEOVER

HSN Code: 8536

Rated Current	IN OPEN EXECUTION		IN SHEET STEEL ENCLOSURE		Recommended HRC Fuse Indo Asian Make
	Cat Ref.	Unit Price (₹)	Cat Ref.	Unit Price (₹)	
125A	ITBE0125	16014	ITBS0125	24472	FSDCP
200A	ITBE0200	29258	ITBS0200	43438	FSF
250A	ITBE0250	29534	ITBS0250	43842	FSK
320A	ITBE0320	30490	ITBS0320	45268	FSK
400A	ITBE0400	44162	ITBS0400	65566	FTS
630A	ITBE0630	51542	ITBS0630	76524	FTS

Price does not include HRC Fuses.

ON-LOAD BY-PASS SWITCHES

HSN Code: 8536

Rated Current	IN OPEN EXECUTION		IN SHEET STEEL ENCLOSURE	
	Cat Ref.	Unit Price (₹)	Cat Ref.	Unit Price (₹)
125A	ITCE0125	22782	ITCS0125	30760
200A	ITCE0200	29008	ITCS0200	39162
250A	ITCE0250	42142	ITCS0250	56890
320A	ITCE0320	43758	ITCS0320	59074
400A	ITCE0400	65636	ITCS0400	88610
630A	ITCE0630	74568	ITCS0630	100672



OFF LOAD CHANGEOVER SWITCH

HSN Code: 8536

 <ul style="list-style-type: none"> • With enclosure • Rated Voltage - 415V-AC 50Hz • Type - FP 	Rating	Cat Ref.	Unit Price (₹)
	32A (DP)	OFDP0032	2064
	16A	OFFP0016	3306
	32A	OFFP0032	3450
	63A	OFFP0063	7012
	100A	OFFP0100	13704
	125A	OFFP0125	19264
	200A	OFFP0200	20798
	250A	OFFP0250	26494
	315A	OFFP0315	27350
	400A	OFFP0400	31906

Prices for spares of Rewirable Switch Fuse Unit like Action Bar, Base Plate, End Shield, Bakelite Contact Shrouds are available on request.

Quality That's Built Into The Design



Shynora

SWITCH & SOCKET



5 COLOUR
FINISHES



HIGH-GRADE
POLYCARBONATE



ROHS
COMPLIANT



FIRE
RETARDANT



ISI MARK



CRS
CERTIFIED

Shynora

WHITE MECHANISMS

SWITCHES: • Polycarbonate Material* • LED Based Indicator • Shrouded Terminal • ISI Marked

SWITCHES 6A 230 V AC

HSN Code: 8536

	Cat. Nos.	Description	Module	Unit Price (₹)	Pack
	810600	6A 1 Way Switch	1	44	1/20/400
	810610	6A 2 Way Switch	1	88	1/20/200
	810602	6A 1 Way Switch with Indicator	1	90	1/20/200
	810604	6A 1 Way Switch with "Light" Marking	1	90	1/20/200
	810605	6A 1Way Switch with "Fan" Marking	1	90	1/20/200

SWITCHES 10A 230 V AC

HSN Code: 8536

	Cat. Nos.	Description	Module	Unit Price (₹)	Pack
	810673	10A 1 Way Switch	1	46	1/20/200
	810674	10A 2 Way Switch	1	92	1/20/200
	810675	10A 1 Way Switch with Indicator	1	92	1/20/200

SWITCHES 16A 230 V AC

HSN Code: 8536

	Cat. Nos.	Description	Module	Unit Price (₹)	Pack
	810601	16A 1 Way Switch	1	108	1/20/200
	810611	16A 2 Way Switch	1	148	1/10/100
	810603	16A 1 Way Switch with Indicator	1	132	1/20/200

SWITCHES 20A 230 V AC

HSN Code: 8536

	Cat. Nos.	Description	Module	Unit Price (₹)	Pack
	810606	20A 1 Way Switch	1	146	1/20/200
	810607	20A 1 Way Switch with Indicator	1	170	1/20/200
	810609	20A SP 1 Way Switch	2	210	1/10/100
	810612	20A DP Switch with Indicator	2	190	1/10/100

SWITCHES 25A 230 V AC

HSN Code: 8536

	Cat. Nos.	Description	Module	Unit Price (₹)	Pack
	810608	25A 1 Way Switch with Indicator	1	198	1/20/200

SWITCHES 32A 230 V AC

HSN Code: 8536

	Cat. Nos.	Description	Module	Unit Price (₹)	Pack
	810613	32A DP Switch with Indicator	2	260	1/10/100

BELL PUSH BUTTON 6A 230 V AC

HSN Code: 8536

	Cat. Nos.	Description	Module	Unit Price (₹)	Pack
	810615	6A Bell Push Switch	1	94	1/20/200
	810616	6A Bell Push Switch with Indicator	1	98	1/20/200
	810617	6A Bell Push Switch with Indicator	2	150	1/10/100

ACCESSORIES FOR SWITCHES

HSN Code: 8536

	Cat. Nos.	Description	Module	Unit Price (₹)	Pack
	810650	LED Indicator for Switches (Red)	-	36	1/5/25

Shynora

SOCKET 240 V AC • Child Safety Shutter • Shrouded Terminals • Smooth Plug removal & insertion

HSN Code: 8536

	Cat. Nos.	Description	Module	Unit Price (₹)	Pack
	810620	6A 3 Pin Round Socket with Shutter (ISI mark)	2	110	1/20/200
	810621	6A/16A 3 Pin Socket with Shutter (ISI Mark)	2	212	1/10/100
	810624	25A 3 Pin Socket with Shutter	2	222	1/10/50

DIMMERS AND FAN REGULATORS • Laser Marking

HSN Code: 8538 & 8414

	Cat. Nos.	Description	Module	Unit Price (₹)	Pack
	810641	Light Dimmer -400W	1	392	1/10/100
	810642	Light Dimmer -500W	2	506	1/10/100
	810638	Fan 4 Step Regulator 100W (ISI mark)	1	368	1/10/100
	810639	Fan Step Regulator 360 deg 100W (ISI mark)	2	484	1/10/100
	810640	Fan 8 step Regulator 100W	2	566	1/10/100

SKIRTING LIGHT

HSN Code: 9405

	Cat. Nos.	Description	Module	Unit Price (₹)	Pack
	810649	Skirting Light	2	376	1/5/50

INDICATOR

HSN Code: 8536

	Cat. Nos.	Description	Module	Unit Price (₹)	Pack
	810645	Flat Indicator Red	1	114	1/20/200

BELL CALL INDICATOR

HSN Code: 8536

	Cat. Nos.	Description	Module	Unit Price (₹)	Pack
	810644	Bell Call Indicator	1	646	1/20/100

BUZZER

HSN Code: 8536

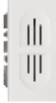
	Cat. Nos.	Description	Module	Unit Price (₹)	Pack
	810637	Buzzer -230V	1	274	1/20/100

**HOSPITALITY FUNCTION
HOTEL KEYCARD SWITCH**

HSN Code: 8538

	Cat. Nos.	Description	Module	Unit Price (₹)	Pack
	810614	32A DP Keytag Switch (Mechanical)	2	440	1/10
	810646	Key Card SW 16A + Key Fob	2	2,272	1/1/10

Shynora

HOSPITALITY FUNCTION HOTEL "DND AND MMR"

HSN Code: 8538

	Cat. Nos.	Description	Module	Unit Price (₹)	Pack
	810647	DND Internal Unit	2	306	1/10/100
	810648	DND External Unit	2	360	1/10/100

SHAVER SOCKET

HSN Code: 8538

	Cat. Nos.	Description	Module	Unit Price (₹)	Pack
	810666	Shaver Socket	4	4,006	1/5/20

SOCKETS AND CONNECTORS

TV SOCKETS

HSN Code: 8536

	Cat. Nos.	Description	Module	Unit Price (₹)	Pack
	810633	TV Socket	1	102	1/20/200

DATA & VOICE

HSN Code: 8536

	Cat. Nos.	Description	Module	Unit Price (₹)	Pack
	810631	Telephone Socket - RJ11 with Shutter	1	100	1/20/200
	810632	Computer Socket - RJ45 Cat 6 with Shutter	1	590	1/20/200

SOUND - ELECTRONIC BELL

HSN Code: 8536

	Cat. Nos.	Description	Module	Unit Price (₹)	Pack
	810643	Electronic Bell	2	264	1/10/100

PROTECTORS AND ACCESSORIES

MOTOR STARTER

HSN Code: 8536

	Cat. Nos.	Description	Module	Unit Price (₹)	Pack
	810664	16A Motor Starter	2	524	10/50
	810665	25A Motor Starter	2	524	10/50

MODULAR MCB (IS : 608981:2002) • ISI Mark

HSN Code: 8536

	Cat. Nos.	Description	Module	Unit Price (₹)	Pack
	810654	6A Mini MCB SP C Curve	1	398	1/1/100
	810655	10A Mini MCB SP C Curve	1	398	1/1/100
	810656	16A Mini MCB SP C Curve	1	398	1/1/100
	810657	20A Mini MCB SP C Curve	1	398	1/1/100
	810658	25A Mini MCB SP C Curve	1	398	1/1/100
	810659	32A Mini MCB SP C Curve	1	398	1/1/100
	810660	16A Mini MCB DP C Curve	2	706	1/1/100
	810661	20A Mini MCB DP C Curve	2	706	1/1/100
	810662	25A Mini MCB DP C Curve	2	706	1/1/100
	810663	32A Mini MCB DP C Curve	2	706	1/1/100

EFFORTLESS CHARGING, SIMPLIFIED LIVING



Shynora

USB CHARGERS

Experience Simplified Living with Type C and Type A+C USBs

Shynora

PROTECTORS AND ACCESSORIES

POWER UNIT

HSN Code: 8536

	Cat. Nos.	Description	Module	Unit Price (₹)	Pack
	810625	Power Unit with 20A MCB & 16A Plug	3	946	1/10
	810626	Power Unit with 25A MCB & 16A Plug	3	1,014	1/10

ELECTRONIC FUNCTION

USB CHARGERS (IS13252 (PART 1) / IEC 60950-1) • CRS Certified

HSN Code: 8536

	Cat. Nos.	Description	Module	Unit Price (₹)	Pack
	810652	USB Charger 1500mA Type A	1	882	1/10/100
	810651	Double USB Charger 3000mA Type A	2	1,412	1/10/100

USB CHARGERS (IS13252 (PART 1) / IEC 60950-1) • CRS Certified

HSN Code: 8536

	Cat. Nos.	Description	Module	Unit Price (₹)	Pack
	810670	USB Charger 1500mA Type C	1	996	1/10/100
	810669	Double USB Charger 3000mA Type A+C	2	1,604	1/10/100

ACCESSORIES

HSN Code: 8538

	Cat. Nos.	Description	Module	Unit Price (₹)	Pack
	810667	1 Module Blank Plate	1	26	1/40/400
	810668	Cable Outlet	1	80	1/20/100

Shynora

COOL GREY MECHANISMS

SWITCHES: • Polycarbonate Material* • LED Based Indicator • Shrouded Terminal • ISI Marked



SWITCHES 6A 230 V AC

HSN Code: 8536

	Cat. Nos.	Description	Module	Unit Price (₹)	Pack
	810700	6A 1 Way Switch	1	52	1/20/400
	810710	6A 2 Way Switch	1	102	1/20/200
	810702	6A 1 Way Switch with Indicator	1	96	1/20/200
	810704	6A 1 Way Switch with "Light" Marking	1	106	1/20/200
	810705	6A 1 Way Switch with "Fan" Marking	1	106	1/20/200

SWITCHES 16A 230 V AC

HSN Code: 8536

	Cat. Nos.	Description	Module	Unit Price (₹)	Pack
	810701	16A 1 Way Switch	1	132	1/20/200
	810711	16A 2 Way Switch* 	1	178	1/10/100
	810703	16A 1 Way Switch with Indicator	1	142	1/20/200

*Will be available for sale from May 2024 onwards

SWITCHES 20A 230 V AC

HSN Code: 8536

	Cat. Nos.	Description	Module	Unit Price (₹)	Pack
	810706	20A 1 Way Switch	1	172	1/20/200
	810707	20A 1 Way Switch with Indicator	1	196	1/20/200
	810709	20A SP 1 Way Switch	2	244	1/10/100
	810712	20A DP Switch with Indicator	2	218	1/10/100

Shynora

SWITCHES 25A 230 V AC

HSN Code: 8536

	Cat. Nos.	Description	Module	Unit Price (₹)	Pack
	810708	25A 1 Way Switch with Indicator	1	216	1/20/200

SWITCHES 32A 230 V AC

HSN Code: 8536

	Cat. Nos.	Description	Module	Unit Price (₹)	Pack
	810713	32A DP Switch with Indicator	2	302	1/10/100

BELL PUSH BUTTON 6A 230 V AC

HSN Code: 8536

	Cat. Nos.	Description	Module	Unit Price (₹)	Pack
	810715	6A Bell Push Switch	1	108	1/20/200
	810716	6A Bell Push Switch with Indicator	1	118	1/20/200
	810717	6A Bell Push Switch with Indicator	2	174	1/10/100

SOCKET 240 V AC • Child Safety Shutter • Shrouded Terminals • Smooth Plug removal & insertion

HSN Code: 8536

	Cat. Nos.	Description	Module	Unit Price (₹)	Pack
	810720	6A 3 Pin Round Socket with Shutter (ISI mark)	2	132	1/20/200
	810721	6A/16A 3 Pin Socket with Shutter (ISI Mark)	2	246	1/10/100
	810724	25A 3 Pin Socket with Shutter	2	264	1/10/50

DIMMERS AND FAN REGULATORS • Laser Marking

HSN Code: 8538 & 8414

	Cat. Nos.	Description	Module	Unit Price (₹)	Pack
	810741	Light Dimmer -400W	1	450	1/10/100
	810742	Light Dimmer -500W	2	592	1/10/100
	810738	Fan 4 Step Regulator 100W (ISI mark)	1	430	1/10/100
	810739	Fan Step Regulator 360 deg 100W (ISI mark)	2	566	1/10/100
	810740	Fan 8 step Regulator 100W	2	710	1/10/100

SKIRTING LIGHT

HSN Code: 9405

	Cat. Nos.	Description	Module	Unit Price (₹)	Pack
	810749	Skirting Light	2	412	1/5/50

INDICATOR

HSN Code: 8536

	Cat. Nos.	Description	Module	Unit Price (₹)	Pack
	810745	Flat Indicator Red	1	122	1/20/200

BUZZER

HSN Code: 8536

	Cat. Nos.	Description	Module	Unit Price (₹)	Pack
	810737	Buzzer -230V	1	318	1/20/100

Shynora

HOSPITALITY FUNCTION HOTEL KEYCARD SWITCH

HSN Code: 8538

	Cat. Nos.	Description	Module	Unit Price (₹)	Pack
	810714	32A DP Keytag Switch (Mechanical)	2	510	1/10
	810746	Key Card SW 16A + Key Fob	2	2,850	1/1/10

HOTEL "DND AND MMR"

HSN Code: 8538

	Cat. Nos.	Description	Module	Unit Price (₹)	Pack
	810747	DND Internal Unit	2	384	1/10/100
	810748	DND External Unit	2	430	1/10/100

SHAVER SOCKET

HSN Code: 8538

	Cat. Nos.	Description	Module	Unit Price (₹)	Pack
	810766	Shaver Socket	4	5,026	1/5/20

SOCKETS AND CONNECTORS

TV SOCKETS

HSN Code: 8536

	Cat. Nos.	Description	Module	Unit Price (₹)	Pack
	810733	TV socket	1	120	1/20/200

DATA & VOICE

HSN Code: 8536

	Cat. Nos.	Description	Module	Unit Price (₹)	Pack
	810731	Telephone Socket - RJ11 with Shutter	1	118	1/20/200
	810732	Computer Socket- RJ45 Cat 6 with Shutter	1	686	1/20/200

PROTECTORS AND ACCESSORIES

MOTOR STARTER

HSN Code: 8536

	Cat. Nos.	Description	Module	Unit Price (₹)	Pack
	810764	16A Motor Starter	2	616	10/50
	810765	25A Motor Starter	2	616	10/50

Shynora

PROTECTORS AND ACCESSORIES

MODULAR MCB (IS : 608981:2002) • ISI Mark

HSN Code: 8536

	Cat. Nos.	Description	Module	Unit Price (₹)	Pack
	810754	6A Mini MCB SP C Curve	1	460	1/1/100
	810755	10A Mini MCB SP C Curve	1	460	1/1/100
	810756	16A Mini MCB SP C Curve	1	460	1/1/100
	810757	20A Mini MCB SP C Curve	1	460	1/1/100
	810758	25A Mini MCB SP C Curve	1	460	1/1/100
	810759	32A Mini MCB SP C Curve	1	460	1/1/100

POWER UNIT

HSN Code: 8536

	Cat. Nos.	Description	Module	Unit Price (₹)	Pack
	810725	Power Unit with 20A MCB & 16A Plug	3	1,102	1/10
	810726	Power Unit with 25A MCB & 16A Plug	3	1,184	1/10

ELECTRONIC FUNCTION

USB CHARGERS (IS13252 (PART 1) / IEC 60950-1) • CRS Certified

HSN Code: 8536

	Cat. Nos.	Description	Module	Unit Price (₹)	Pack
	810752	USB Charger 1500mA Type A	1	1,104	1/10/100
	810751	Double USB Charger 3000mA Type A	2	1,632	1/10/100

USB CHARGERS (IS13252 (PART 1) / IEC 60950-1) • CRS Certified

HSN Code: 8536

	Cat. Nos.	Description	Module	Unit Price (₹)	Pack
	810770	USB Charger 1500mA Type C	1	1,132	1/10/100
	810769	Double USB Charger 3000mA Type A + C	2	1,828	1/10/100

ACCESSORIES

HSN Code: 8538



	Cat. Nos.	Description	Module	Unit Price (₹)	Pack
	810767	1 Module Blank Plate	1	32	1/40/400
	810768	Cable Outlet	1	86	1/20/100

PLATE & FRAME • Strong Dimensional Stability

WHITE MODULAR PLATE WITH SUPPORT FRAME

HSN Code: 8538

	Cat. Nos.	Description	Module	Unit Price (₹)	Pack
	810800	White Plate + Frame, 1 module	1	80	1/10/100
	810801	White Plate + Frame, 2 module	2	80	1/10/100
	810802	White Plate + Frame, 3 module	3	122	1/10/100
	810803	White Plate + Frame, 4 module	4	130	1/10/100
	810804	White Plate + Frame, 6 module	6	178	1/5/50
	810805	White Plate + Frame, 8 module	8	230	1/5/50
	810806	White Plate + Frame, 2X4 module	8	230	1/5/25
	810807	White Plate + Frame, 9 module	9	258	1/5/50
	810808	White Plate + Frame, 12 module	12	302	1/5/25
	810809	White Plate + Frame, 16 module	16	340	1/5/25
	810810	White Plate + Frame, 18 module	18	408	1/5/25

Shynora

COOL GREY MODULAR PLATE WITH SUPPORT FRAME

HSN Code: 8538

	Cat. Nos.	Description	Module	Unit Price (₹)	Pack
	810811	Cool Grey Plate + Frame, 1 module	1	100	1/10/100
	810812	Cool Grey Plate + Frame, 2 module	2	100	1/10/100
	810813	Cool Grey Plate + Frame, 3 module	3	146	1/10/100
	810814	Cool Grey Plate + Frame, 4 module	4	158	1/10/100
	810815	Cool Grey Plate + Frame, 6 module	6	220	1/5/50
	810816	Cool Grey Plate + Frame, 8 module	8	254	1/5/50
	810817	Cool Grey Plate + Frame, 2X4 module	8	260	1/5/25
	810818	Cool Grey Plate + Frame, 9 module	9	314	1/5/50
	810819	Cool Grey Plate + Frame, 12 module	12	368	1/5/25
	810820	Cool Grey Plate + Frame, 16 module	16	414	1/5/25
810821	Cool Grey Plate + Frame, 18 module	18	500	1/5/25	

CHROME MODULAR PLATE WITH SUPPORT FRAME

HSN Code: 8538

	Cat. Nos.	Description	Module	Unit Price (₹)	Pack
	810833	Chrome Plate + Frame, 1 module	1	92	1/10/100
	810834	Chrome Plate + Frame, 2 module	2	92	1/10/100
	810835	Chrome Plate + Frame, 3 module	3	128	1/10/100
	810836	Chrome Plate + Frame, 4 module	4	148	1/10/100
	810837	Chrome Plate + Frame, 6 module	6	204	1/5/50
	810838	Chrome Plate + Frame, 8 module	8	240	1/5/50
	810839	Chrome Plate + Frame, 2X4 module	8	246	1/5/25
	810840	Chrome Plate + Frame, 9 module	9	296	1/5/50
	810841	Chrome Plate + Frame, 12 module	12	342	1/5/25
	810842	Chrome Plate + Frame, 16 module	16	392	1/5/25
	810843	Chrome Plate + Frame, 18 module	18	468	1/5/25

PINK MODULAR PLATE WITH SUPPORT FRAME

HSN Code: 8538

	Cat. Nos.	Description	Module	Unit Price (₹)	Pack
	810844	Pink Plate + Frame, 1 module	1	112	1/10/100
	810845	Pink Plate + Frame, 2 module	2	112	1/10/100
	810846	Pink Plate + Frame, 3 module	3	152	1/10/100
	810847	Pink Plate + Frame, 4 module	4	176	1/10/100
	810848	Pink Plate + Frame, 6 module	6	250	1/5/50
	810849	Pink Plate + Frame, 8 module	8	308	1/5/50
	810850	Pink Plate + Frame, 2X4 module	8	308	1/5/25
	810851	Pink Plate + Frame, 9 module	9	362	1/5/50
	810852	Pink Plate + Frame, 12 module	12	416	1/5/25
	810853	Pink Plate + Frame, 16 module	16	522	1/5/25
	810854	Pink Plate + Frame, 18 module	18	566	1/5/25

Shynora

MILAN GOLD MODULAR PLATE WITH SUPPORT FRAME

HSN Code: 8538

	Cat. Nos.	Description	Module	Unit Price (₹)	Pack
	810855	Milan Gold Plate + Frame, 1 module	1	112	1/10/100
	810856	Milan Gold Plate + Frame, 2 module	2	112	1/10/100
	810857	Milan Gold Plate + Frame, 3 module	3	152	1/10/100
	810858	Milan Gold Plate + Frame, 4 module	4	176	1/10/100
	810859	Milan Gold Plate + Frame, 6 module	6	250	1/5/50
	810860	Milan Gold Plate + Frame, 8 module	8	308	1/5/50
	810861	Milan Gold Plate + Frame, 2X4 module	8	308	1/5/25
	810862	Milan Gold Plate + Frame, 9 module	9	362	1/5/50
	810863	Milan Gold Plate + Frame, 12 module	12	416	1/5/25
	810864	Milan Gold Plate + Frame, 16 module	16	522	1/5/25
810865	Milan Gold Plate + Frame, 18 module	18	566	1/5/25	

METAL FLUSH BOX • Made of G.I. Sheet • Earth Terminal for Safety • Provision for Knockouts Available

HSN Code: 8538

	Cat. Nos.	Description	Module	Unit Price (₹)	Pack
	800172	Metal Flush Box, 1/2 Module	1/2	66	1/40
	800173	Metal Flush Box, 3 Module	3	86	1/40
	800174	Metal Flush Box, 4 Module	4	100	1/40
	800176	Metal Flush Box, 6 Module	6	154	1/20
	800177	Metal Flush Box, 8 Module (vertical)	8	198	1/20
	800178	Metal Flush Box, 8 Module	8	198	1/20
	810867	Metal Flush Box, 9 Module	9	234	1/20
	800175	Metal Flush Box, 12 Module	12	258	1/10
	800179	Metal Flush Box, 16 Module	16	296	1/10
	800180	Metal Flush Box, 18 Module	18	324	1/10

WHITE SURFACE BOX • Flame Retardant Material • Edge to Edge Fitting with Plate

HSN Code: 8538

	Cat. Nos.	Description	Module	Unit Price (₹)	Pack
	800182	Plastic Surface Box, 1/2 Module	1/2	68	1/50
	800183	Plastic Surface Box, 3 Module	3	86	1/35
	800184	Plastic Surface Box, 4 Module	4	98	1/35
	800186	Plastic Surface Box, 6 Module	6	150	1/10
	800187	Plastic Surface Box, 8 Module (vertical)	8	204	1/15
	810866	Plastic Surface Box, 8 Module	8	216	1/10
	800185	Plastic Surface Box, 12 Module	12	256	1/10
	800189	Plastic Surface Box, 16 Module	16	298	1/10
	800190	Metal Surface Box, 18 Module	18	334	1/10

Cover Plates - Shynora

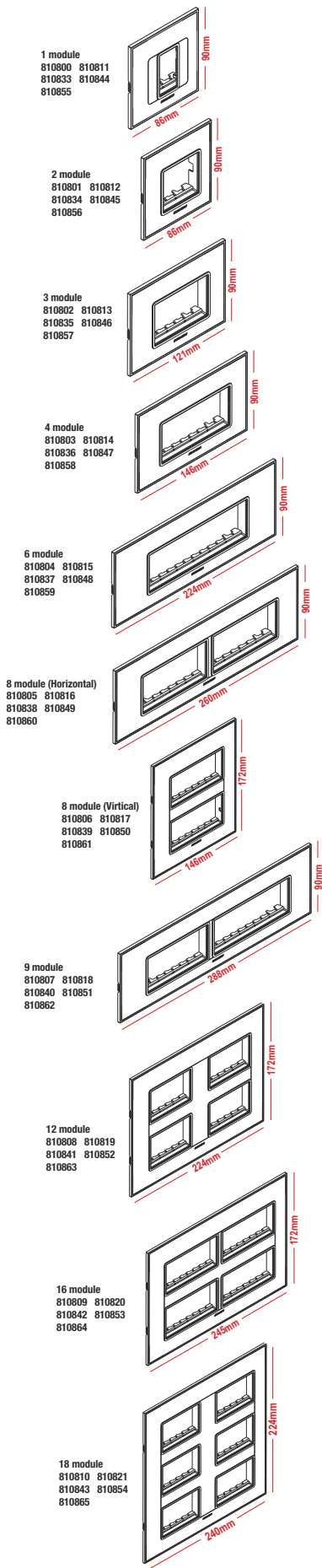

Flush Boxes-Metal

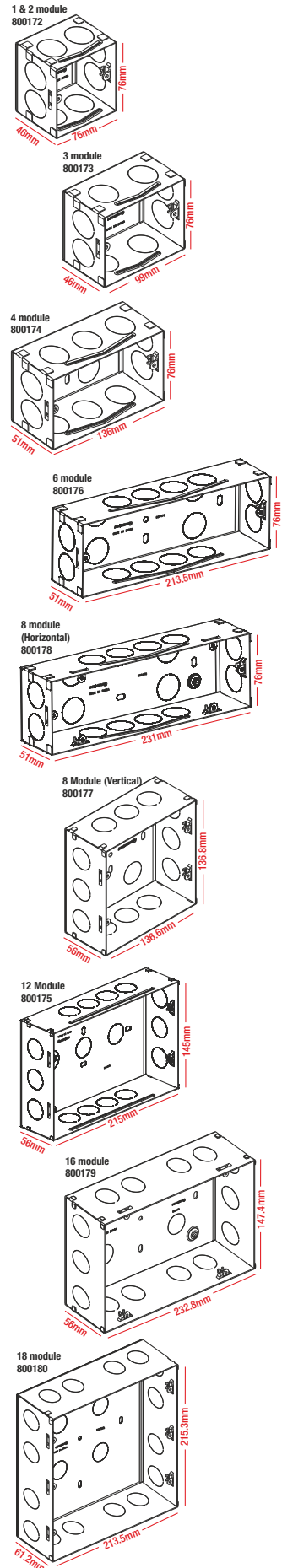

Surface Boxes-Plastic

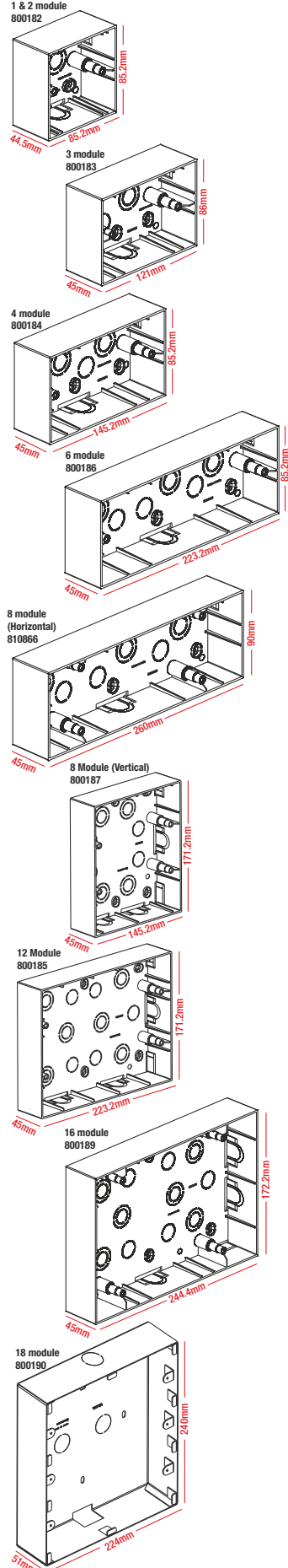

ADD THE
ELEGANCE
OF **COLOUR** TO
YOUR SPACE!

WELCOME CHANGE!



Glint™
Welcome Change

Glint™
WHITE MECHANISMS

SWITCHES: • Polycarbonate Material • LED Based Indicator • ISI Marked

SWITCHES 6A 230 V AC

HSN Code: 8536

	Cat. Nos.	Description	Module	Unit Price (₹)	Pack
	800000	6A 1 Way Switch	1	34	1/20/400
800001	6A 2 Way Switch	1	68	1/20/200	

SWITCHES 16A 230 V AC

HSN Code: 8536

	Cat. Nos.	Description	Module	Unit Price (₹)	Pack
	800002	16A 1 Way Switch	1	94	1/20/200
800003	16A 2 Way Switch	1	118	1/10/100	
800004	16A 1 way Switch with Indicator	1	114	1/10/100	

SWITCHES 20A 230 V AC

HSN Code: 8536

	Cat. Nos.	Description	Module	Unit Price (₹)	Pack
	800005	20A DP Switch with Indicator	2	142	1/10/50

Switches 25A 230V AC

HSN Code: 8536

	Cat. Nos.	Description	Module	Unit Price (₹)	Pack
	800089	25A Switch with Indicator	1	122	1/10/100

SWITCHES 32A 230 V AC

HSN Code: 8536

	Cat. Nos.	Description	Module	Unit Price (₹)	Pack
	800006	32A DP Switch with Indicator	2	208	1/10/50

BELL PUSH BUTTON 6A 230 V AC

HSN Code: 8536

	Cat. Nos.	Description	Module	Unit Price (₹)	Pack
	800007	6A Bell Push with Indicator	1	82	1/10/100
800008	6A Bell Push with Indicator	2	120	1/10/100	

SOCKET 240 V AC • Child Safety Shutter • Smooth Plug removal & insertion

HSN Code: 8536

	Cat. Nos.	Description	Module	Unit Price (₹)	Pack
	801800	6A 3 Pin Round Socket with Shutter (ISI mark)	2	68	1/20/200
800022	6A/16A 3 Pin Socket with Shutter (ISI Mark)	2	128	1/10/100	

DIMMERS AND FAN REGULATORS • Laser Marking for Easy Identification

HSN Code: 8538 & 8414

	Cat. Nos.	Description	Module	Unit Price (₹)	Pack
	800042	Light Dimmer -400W	1	314	1/10/100
800041	Fan 4 Step Regulator -100W	1	322	1/10/100	
800043	Fan 4 Step Regulator -100W	2	362	1/10/100	
800090	Fan 5 Step Regulator -100W (ISI mark)	2	266	1/10/100	
800091	Fan 8 Step Regulator -100W	2	322	1/10/100	



BRING HOME OUR STUNNING HOSPITALITY RANGE



Glint [™]
Welcome Change

Glint™
SKIRTING LIGHT

HSN Code: 8536

 	Cat. Nos.	Description	Module	Unit Price (₹)	Pack
		800092	Skirting Light 2M	2	232

INDICATOR

HSN Code: 8536

	Cat. Nos.	Description	Module	Unit Price (₹)	Pack
	800033	Flat Indicator Red	1	92	1/10/100



BUZZER

HSN Code: 8536

	Cat. Nos.	Description	Module	Unit Price (₹)	Pack
	800040	Buzzer 230V	1	182	1/20/100



HOSPITALITY FUNCTION
HOTEL KEYCARD SWITCH

HSN Code: 8536

 	Cat. Nos.	Description	Module	Unit Price (₹)	Pack
	800093	32A DP Keytag Switch (Mechanical)	2	316	1/10

HOTEL "DND AND MMR" FUNCTIONS

HSN Code: 8536

 	Cat. Nos.	Description	Module	Unit Price (₹)	Pack
	800094	DND Internal Unit	2	118	1/10/100
	800095	DND External Unit	2	208	1/10/100

SOCKETS AND CONNECTORS

TV SOCKETS

HSN Code: 8536

	Cat. Nos.	Description	Module	Unit Price (₹)	Pack
	800032	TV Socket	1	66	1/20/100

DATA & VOICE

HSN Code: 8536

	Cat. Nos.	Description	Module	Unit Price (₹)	Pack
	800030	Telephone Socket - RJ11	1	72	1/20/100
	800031	Computer Socket- RJ45 Cat 6	1	168	1/20/100

PROTECTORS AND ACCESSORIES



MODULAR MCB (IS : 608981:2002) • Laser marking

HSN Code: 8536

	Cat. Nos.	Description	Module	Unit Price (₹)	Pack
	800097	6A Mini MCB SP C Curve	1	200	1/10/100
	800098	10A Mini MCB SP C Curve	1	200	1/10/100
	800010	16A Mini MCB SP C Curve	1	306	1/10/100
	800011	20A Mini MCB SP C Curve	1	306	1/10/100
	800012	25A Mini MCB SP C Curve	1	306	1/10/100
	800013	32A Mini MCB SP C Curve	1	306	1/10/100

Glint™
MOTOR STARTER

HSN Code: 8536

 	Cat. Nos.	Description	Module	Unit Price (₹)	Pack
		800096	25A MOTOR STARTER	2	334

ELECTRONIC FUNCTION

USB CHARGERS (IS13252 (PART 1) / IEC 60950-1) • CRS Certified

HSN Code: 8536

	Cat. Nos.	Description	Module	Unit Price (₹)	Pack
		800044	USB Charger 1500mA Type A	1	758

ACCESSORIES • Spare Screw Caps

HSN Code: 8538

	Cat. Nos.	Description	Module	Unit Price (₹)	Pack
	800051	1 Module Blank Plate	1	22	1/20/200
	800052	2 Module Blank Plate	2	26	1/10/100
	800059	Screw Caps		22	1/10/100

Glint™
WHITE GLINT PLATE

PLATE: • Unique Design - Sleek & Curvy • Flame Retardant Material • Compatible with Standard Size of Metal Flush & Plastic Surface Boxes

HSN Code: 8538

	Cat. Nos.	Description	Module	Unit Price (₹)	Pack
	800061	1 Module Plate	1	48	1/10/100
	800062	2 Module Plate	2	48	1/10/100
	800063	3 Module Plate	3	70	1/10/100
	800064	4 Module Plate	4	82	1/10/100
	800066	6 Module Plate	6	104	1/5/50
	800067	8 Module Plate (vertical)	8	144	1/5/25
	800068	8 Module Plate (horizontal)	8	136	1/5/50
	800065	12 Module Plate	12	188	1/5/25
	800069	16 Module Plate	16	196	1/5/25
	800070	18 Module Plate	18	238	1/5/25

WHITE GLINT PLATE WITH FRAME

PLATE & FRAME: • Aesthetic Design • Suitable for Metal Flush & Wooden Boxes • Comes with Regular & Self Tapping Screws

HSN Code: 8538

	Cat. Nos.	Description	Module	Unit Price (₹)	Pack
	800071	White Plate + Frame, 1M	1	74	1/10/100
	800072	White Plate + Frame, 2M	2	74	1/10/100
	800073	White Plate + Frame, 3M	3	94	1/10/100
	800074	White Plate + Frame, 4M	4	118	1/10/100
	800076	White Plate + Frame, 6M	6	148	1/10/50
	800078	White Plate + Frame, 8M (Vertical)	8	212	1/5/25
	800079	White Plate + Frame, 8M (Horizontal)	8	212	1/10/50
	800080	White Plate + Frame, 10M	10	250	1/5/25
	800082	White Plate + Frame, 12M (Vertical)	12	272	1/5/25
	800084	White Plate + Frame, 12M (Horizontal)	12	272	1/5/25
	800086	White Plate + Frame, 16M	16	310	1/5/25
	800088	White Plate + Frame, 18M	18	336	1/5/25

Glint™

METALLIC GREY GLINT PLATE WITH FRAME

HSN Code: 8538

	Cat. Nos.	Description	Module	Unit Price (₹)	Pack
	800241	Metallic Grey Plate + Frame, 1M	1	108	1/10/100
	800242	Metallic Grey Plate + Frame, 2M	2	108	1/10/100
	800243	Metallic Grey Plate + Frame, 3M	3	134	1/10/100
	800244	Metallic Grey Plate + Frame, 4M	4	168	1/10/100
	800245	Metallic Grey Plate + Frame, 6M	6	208	1/10/50
	800246	Metallic Grey Plate + Frame, 8M (Horizontal)	8	296	1/5/25
	800247	Metallic Grey Plate + Frame, 8M (Vertical)	8	296	1/10/50
	800248	Metallic Grey Plate + Frame, 10M	10	348	1/5/25
	800249	Metallic Grey Plate + Frame, 12M (Horizontal)	12	380	1/5/25
	800250	Metallic Grey Plate + Frame, 12M (Vertical)	12	380	1/5/25
	800251	Metallic Grey Plate + Frame, 16M	16	504	1/5/25
	800252	Metallic Grey Plate + Frame, 18M	18	536	1/5/25

METALLIC GOLD GLINT PLATE WITH FRAME

HSN Code: 8538

	Cat. Nos.	Description	Module	Unit Price (₹)	Pack
	800253	Metallic Gold Plate + Frame, 1M	1	108	1/10/100
	800254	Metallic Gold Plate + Frame, 2M	2	108	1/10/100
	800255	Metallic Gold Plate + Frame, 3M	3	134	1/10/100
	800256	Metallic Gold Plate + Frame, 4M	4	168	1/10/100
	800257	Metallic Gold Plate + Frame, 6M	6	208	1/10/50
	800258	Metallic Gold Plate + Frame, 8M (Horizontal)	8	296	1/5/25
	800259	Metallic Gold Plate + Frame, 8M (Vertical)	8	296	1/10/50
	800260	Metallic Gold Plate + Frame, 10M	10	348	1/5/25
	800261	Metallic Gold Plate + Frame, 12M (Horizontal)	12	380	1/5/25
	800262	Metallic Gold Plate + Frame, 12M (Vertical)	12	380	1/5/25
	800263	Metallic Gold Plate + Frame, 16M	16	504	1/5/25
	800264	Metallic Gold Plate + Frame, 18M	18	536	1/5/25

METALLIC PLUM GLINT PLATE WITH FRAME

HSN Code: 8538

	Cat. Nos.	Description	Module	Unit Price (₹)	Pack
	800265	Metallic Plum Plate + Frame, 1M	1	108	1/10/100
	800266	Metallic Plum Plate + Frame, 2M	2	108	1/10/100
	800267	Metallic Plum Plate + Frame, 3M	3	134	1/10/100
	800268	Metallic Plum Plate + Frame, 4M	4	168	1/10/100
	800269	Metallic Plum Plate + Frame, 6M	6	208	1/10/50
	800270	Metallic Plum Plate + Frame, 8M (Horizontal)	8	296	1/5/25
	800271	Metallic Plum Plate + Frame, 8M (Vertical)	8	296	1/10/50
	800272	Metallic Plum Plate + Frame, 10M	10	348	1/5/25
	800273	Metallic Plum Plate + Frame, 12M (Horizontal)	12	380	1/5/25
	800274	Metallic Plum Plate + Frame, 12M (Vertical)	12	380	1/5/25
	800275	Metallic Plum Plate + Frame, 16M	16	504	1/5/25
	800276	Metallic Plum Plate + Frame, 18M	18	536	1/5/25

Glint™

METALLIC MINT GLINT PLATE WITH FRAME

HSN Code: 8538

	Cat. Nos.	Description	Module	Unit Price (₹)	Pack
	800277	Metallic Mint Plate + Frame, 1M	1	108	1/10/100
	800278	Metallic Mint Plate + Frame, 2M	2	108	1/10/100
	800279	Metallic Mint Plate + Frame, 3M	3	134	1/10/100
	800280	Metallic Mint Plate + Frame, 4M	4	168	1/10/100
	800281	Metallic Mint Plate + Frame, 6M	6	208	1/10/50
	800282	Metallic Mint Plate + Frame, 8M (Horizontal)	8	296	1/5/25
	800283	Metallic Mint Plate + Frame, 8M (Vertical)	8	296	1/10/50
	800284	Metallic Mint Plate + Frame, 10M	10	348	1/5/25
	800285	Metallic Mint Plate + Frame, 12M (Horizontal)	12	380	1/5/25
	800286	Metallic Mint Plate + Frame, 12M (Vertical)	12	380	1/5/25
	800287	Metallic Mint Plate + Frame, 16M	16	504	1/5/25
	800288	Metallic Mint Plate + Frame, 18M	18	536	1/5/25

METAL FLUSH BOX • Made of G.I. Sheet • Earth Terminal for Safety • Provision for Knockouts Available

HSN Code: 8538

	Cat. Nos.	Description	Module	Unit Price (₹)	Pack
	800172	Metal Flush Box, 1/2 Module	1/2	66	40
	800173	Metal Flush Box, 3 Module	3	86	40
	800174	Metal Flush Box, 4 Module	4	100	40
	800176	Metal Flush Box, 6 Module	6	154	20
	800177	Metal Flush Box, 8 Module (vertical)	8	198	20
	800178	Metal Flush Box, 8 Module	8	198	20
	810867	Metal Flush Box, 9 Module	9	234	20
	800175	Metal Flush Box, 12 Module	12	258	10
	800179	Metal Flush Box, 16 Module	16	296	10
	800180	Metal Flush Box, 18 Module	18	324	10

WHITE SURFACE BOX • Flame Retardant Material • Edge to Edge Fitting with Plate

HSN Code: 8538

	Cat. Nos.	Description	Module	Unit Price (₹)	Pack
	800182	Plastic Surface Box, 1/2 Module	1/2	68	50
	800183	Plastic Surface Box, 3 Module	3	86	35
	800184	Plastic Surface Box, 4 Module	4	98	35
	800186	Plastic Surface Box, 6 Module	6	150	10
	800187	Plastic Surface Box, 8 Module (vertical)	8	204	15
	800188	Plastic Surface Box, 8 Module	8	204	10
	800185	Plastic Surface Box, 12 Module	12	256	10
	800189	Plastic Surface Box, 16 Module	16	298	10
	800190	Metal Surface Box, 18 Module	18	334	10

Cover Plates - Glint™

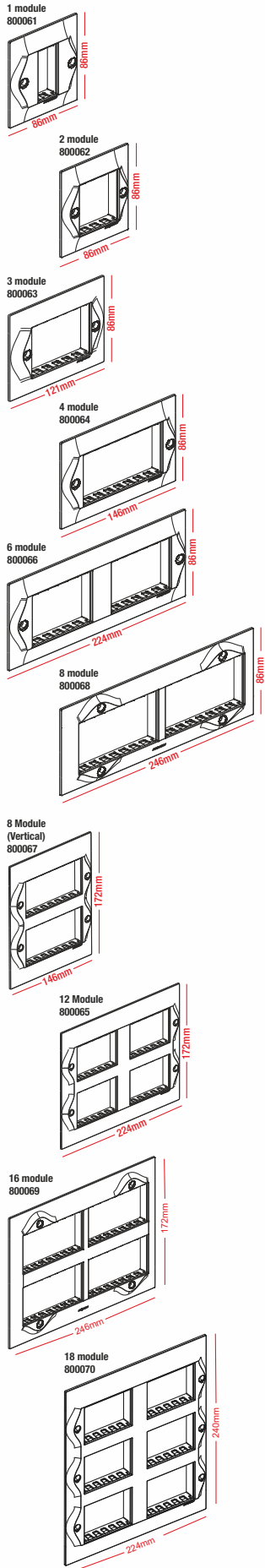

Flush Boxes-Metal

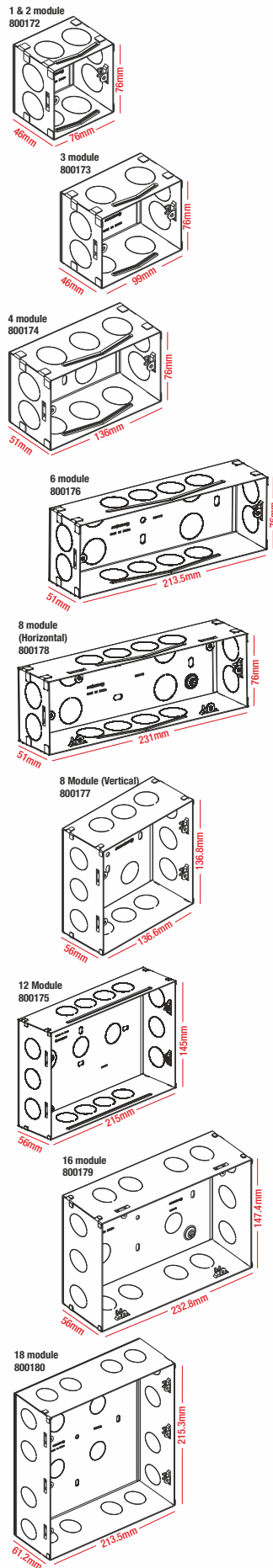

Surface Boxes-Plastic

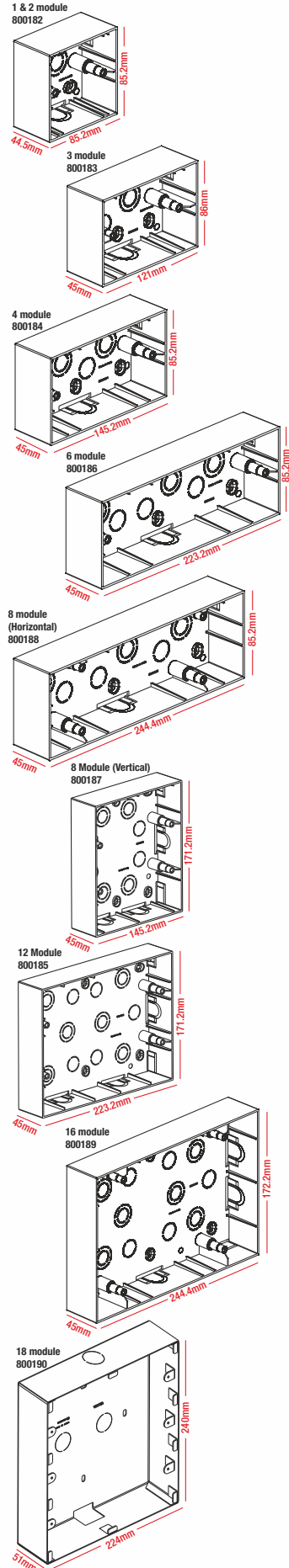

COLOURS THAT REFLECT
YOUR PERSONALITY.



ELVIRA
A SENSIBLE SWITCH

ELVIRA
A SENSIBLE SWITCH

WHITE MECHANISMS

SWITCHES: • Polycarbonate Material* • LED Based Indicator • ISI Marked

SWITCHES 6A 230 V AC

HSN Code: 8536

	Cat. Nos.	Description	Module	Unit Price (₹)	Pack
	800100	6A 1 Way Switch	1	38	1/20/400
	800101	6A 2 Way Switch	1	86	1/20/100
	800102	6A 1 Way Switch with Indicator	1	84	1/20/200

SWITCHES 10A 230 V AC

HSN Code: 8536

	Cat. Nos.	Description	Module	Unit Price (₹)	Pack
	800114	10A 1 Way Switch	1	40	1/20/400
	800115	10A 2 Way Switch	1	88	1/20/100
	800116	10A 1 Way Switch with Indicator	1	86	1/20/200

SWITCHES 16A 230 V AC

HSN Code: 8536

	Cat. Nos.	Description	Module	Unit Price (₹)	Pack
	800103	16A 1 Way Switch	1	104	1/20/200
	800104	16A 2 Way Switch	1	148	1/10/100
	800105	16A 1 Way Switch with Indicator	1	130	1/20/200

SWITCHES 20A 230 V AC

HSN Code: 8536

	Cat. Nos.	Description	Module	Unit Price (₹)	Pack
	800107	20A DP Switch with Indicator	2	184	1/10/50

SWITCHES 25A 230 V AC

HSN Code: 8536

	Cat. Nos.	Description	Module	Unit Price (₹)	Pack
	800106	25A 1 Way Switch with Indicator	1	192	1/10/100

SWITCHES 32A 230 V AC

HSN Code: 8536

	Cat. Nos.	Description	Module	Unit Price (₹)	Pack
	800108	32A DP Switch with Indicator	2	254	1/10/50

BELL PUSH BUTTON 6A 230 V AC

HSN Code: 8536

	Cat. Nos.	Description	Module	Unit Price (₹)	Pack
	800110	6A Bell Push with Indicator	1	92	1/20/200
	800111	6A Bell Push with Indicator	2	146	1/10/100

SOCKET 240 V AC • Child Safety Shutter • Smooth Plug removal & insertion

HSN Code: 8536

	Cat. Nos.	Description	Module	Unit Price (₹)	Pack
	802800	6A 3 Pin Round Socket with Shutter (ISI mark)	2	90	1/20/200
	800122	6A/16A 3 Pin socket with Shutter (ISI Mark)	2	174	1/10/50
	800124	25A 3 Pin Socket with Shutter	2	200	1/10/50

ELVIRA
A SENSIBLE SWITCH

DIMMERS AND FAN REGULATORS • Laser Marking for Easy Identification

HSN Code: 8538 & 8414

	Cat. Nos.	Description	Module	Unit Price (₹)	Pack
	800143	Light Dimmer 400W	1	372	1/10/100
	800141	Fan 4 Step Regulator 100W (ISI Mark)	1	358	1/10/100
	800142	Fan 4 Step Regulator 100W (ISI Mark)	2	436	1/10/100
	800139	Fan 8 step Regulator 100W	2	536	1/10/100

SKIRTING LIGHT

HSN Code: 8536

	Cat. Nos.	Description	Module	Unit Price (₹)	Pack
	800155	Skirting Light	2	376	1/5/25

INDICATOR

HSN Code: 8536

	Cat. Nos.	Description	Module	Unit Price (₹)	Pack
	800154	Flat Indicator Red	1	106	1/20/100

BUZZER

HSN Code: 8536

	Cat. Nos.	Description	Module	Unit Price (₹)	Pack
	800140	Buzzer 230V	1	266	1/20/100

BELL CALL INDICATOR

HSN Code: 8536

	Cat. Nos.	Description	Module	Unit Price (₹)	Pack
	800144	Bell Call indicator	1	568	1/20/100

SOCKETS AND CONNECTORS

TV SOCKETS

HSN Code: 8536

	Cat. Nos.	Description	Module	Unit Price (₹)	Pack
	800132	TV Socket	1	92	1/20/100

DATA & VOICE

HSN Code: 8536

	Cat. Nos.	Description	Module	Unit Price (₹)	Pack
	800130	Telephone Socket - RJ11	1	94	1/20/100
	800131	Computer Socket - RJ45 Cat 6	1	244	1/20/100

ELVIRA
A SENSIBLE SWITCH

PROTECTORS AND ACCESSORIES
MOTOR STARTER

HSN Code: 8536

	Cat. Nos.	Description	Module	Unit Price (₹)	Pack
	800196	25A Motor Starter	2	434	10/50

MODULAR MCB (IS : 608981:2002) • Laser marking

HSN Code: 8536

	Cat. Nos.	Description	Module	Unit Price (₹)	Pack
	800160	16A Mini MCB SP C Curve	1	386	1/10/100
	800191	20A Mini MCB SP C Curve	1	386	1/10/100
	800156	25A Mini MCB SP C Curve	1	386	1/10/100
	800157	32A Mini MCB SP C Curve	1	386	1/10/100

PROTECTORS AND ACCESSORIES
POWER UNIT

HSN Code: 8536

	Cat. Nos.	Description	Module	Unit Price (₹)	Pack
	800193	Power Unit with 20A MCB & 16A Plug	3	910	1/10
	800194	Power Unit with 25A MCB & 16A Plug	3	978	1/10

ELECTRONIC FUNCTION

USB CHARGERS (IS13252 (PART 1) / IEC 60950-1) • CRS Certified

HSN Code: 8536

	Cat. Nos.	Description	Module	Unit Price (₹)	Pack
	800145	USB charger 1500mA Type A	1	850	1/10/100

HOSPITALITY FUNCTION
HOTEL KEYCARD SWITCH

HSN Code: 8538

	Cat. Nos.	Description	Module	Unit Price (₹)	Pack
	800197	Key card Switch 16A	2	2,172	1/10

HOTEL "DND AND MMR"

HSN Code: 8538

	Cat. Nos.	Description	Module	Unit Price (₹)	Pack
	800192	DND Internal Unit	2	186	1/10/100
	800195	DND External Unit	2	222	1/10/100

ACCESSORIES

HSN Code: 8538

	Cat. Nos.	Description	Module	Unit Price (₹)	Pack
	800151	1 Module Blank Plate	1	26	1/20/200
	800152	2 Module Blank Plate	2	44	1/10/100
	800153	Cable Outlet	1	76	1/20/100

ELVIRA
A SENSIBLE SWITCH

PLATE & FRAME

WHITE MODULAR PLATE WITH SUPPORT FRAME • Strong Dimensional Stability

HSN Code: 8538

	Cat. Nos.	Description	Module	Unit Price (₹)	Pack
	800161	White Plate + Frame, 1M	1	78	1/10/100
	800162	White Plate + Frame, 2M	2	78	1/10/100
	800163	White Plate + Frame, 3M	3	106	1/10/100
	800164	White Plate + Frame, 4M	4	122	1/10/100
	800166	White Plate + Frame, 6M	6	156	1/5/50
	800167	White Plate + Frame, 8M(Vertical)	8	218	1/5/25
	800168	White Plate + Frame, 8M(Horizontal)	8	216	1/5/50
	800165	White Plate + Frame, 12M	12	292	1/5/25
	800169	White Plate + Frame, 16M	16	338	1/5/25
800170	White Plate + Frame, 18M	18	402	1/5/25	

SILVER LIGHT PURPLE MODULAR PLATE WITH SUPPORT FRAME

HSN Code: 8538

	Cat. Nos.	Description	Module	Unit Price (₹)	Pack
	800201	Silver Light Purple Plate + Frame, 1M	1	108	1/10/100
	800202	Silver Light Purple Plate + Frame, 2M	2	108	1/10/100
	800203	Silver Light Purple Plate + Frame, 3M	3	136	1/10/100
	800204	Silver Light Purple Plate + Frame, 4M	4	168	1/10/100
	800205	Silver Light Purple Plate + Frame, 6M	6	224	1/5/50
	800206	Silver Light Purple Plate+Frame, 8M (Horizontal)	8	300	1/5/50
	800207	Silver Light Purple Plate+Frame, 8M (Vertical)	8	300	1/5/25
	800208	Silver Light Purple Plate + Frame, 12M	12	382	1/5/25
	800209	Silver Light Purple Plate + Frame, 16M	16	506	1/5/25
800210	Silver Light Purple Plate + Frame, 18M	18	542	1/5/25	

INOX SILVER MODULAR PLATE WITH SUPPORT FRAME

HSN Code: 8538

	Cat. Nos.	Description	Module	Unit Price (₹)	Pack
	800211	Inox Silver Plate + Frame, 1M	1	108	1/10/100
	800212	Inox Silver Plate + Frame, 2M	2	108	1/10/100
	800213	Inox Silver Plate + Frame, 3M	3	136	1/10/100
	800214	Inox Silver Plate + Frame, 4M	4	168	1/10/100
	800215	Inox Silver Plate + Frame, 6M	6	224	1/5/50
	800216	Inox Silver Plate + Frame, 8M (Horizontal)	8	300	1/5/50
	800217	Inox Silver Plate + Frame, 8M (Vertical)	8	300	1/5/25
	800218	Inox Silver Plate + Frame, 12M	12	382	1/5/25
	800219	Inox Silver Plate + Frame, 16M	16	506	1/5/25
800220	Inox Silver Plate + Frame, 18M	18	542	1/5/25	

ELVIRA
A SENSIBLE SWITCH

POLARIZED GREY MODULAR PLATE WITH SUPPORT FRAME

HSN Code: 8538

	Cat. Nos.	Description	Module	Unit Price (₹)	Pack
	800221	Polarized Grey Plate + Frame 1M	1	108	1/10/100
	800222	Polarized Grey Plate + Frame 2M	2	108	1/10/100
	800223	Polarized Grey Plate + Frame 3M	3	136	1/10/100
	800224	Polarized Grey Plate + Frame 4M	4	168	1/10/100
	800225	Polarized Grey Plate + Frame 6M	6	224	1/5/50
	800226	Polarized Grey Plate + Frame 8M (Horizontal)	8	300	1/5/50
	800227	Polarized Grey Plate + Frame 8M (Vertical)	8	300	1/5/25
	800228	Polarized Grey Plate + Frame 12M	12	382	1/5/25
	800229	Polarized Grey Plate + Frame 16M	16	506	1/5/25
800230	Polarized Grey Plate + Frame 18M	18	542	1/5/25	

ASH PURPLE MODULAR PLATE WITH SUPPORT FRAME

HSN Code: 8538

	Cat. Nos.	Description	Module	Unit Price (₹)	Pack
	800231	Ash Purple Plate + Frame, 1M	1	108	1/10/100
	800232	Ash Purple Plate + Frame, 2M	2	108	1/10/100
	800233	Ash Purple Plate + Frame, 3M	3	136	1/10/100
	800234	Ash Purple Plate + Frame, 4M	4	168	1/10/100
	800235	Ash Purple Plate + Frame, 6M	6	224	1/5/50
	800236	Ash Purple Plate + Frame, 8M (Horizontal)	8	300	1/5/50
	800237	Ash Purple Plate + Frame, 8M (Vertical)	8	300	1/5/25
	800238	Ash Purple Plate + Frame, 12M	12	382	1/5/25
	800239	Ash Purple Plate + Frame, 16M	16	506	1/5/25
800240	Ash Purple Plate + Frame, 18M	18	542	1/5/25	

METAL FLUSH BOX • Made of G.I. Sheet • Earth Terminal for Safety • Provision for Knockouts Available

HSN Code: 8538

	Cat. Nos.	Description	Module	Unit Price (₹)	Pack
	800172	Metal Flush Box, 1/2 Module	1/2	66	40
	800173	Metal Flush Box, 3 Module	3	86	40
	800174	Metal Flush Box, 4 Module	4	100	40
	800176	Metal Flush Box, 6 Module	6	154	20
	800177	Metal Flush Box, 8 Module (vertical)	8	198	20
	800178	Metal Flush Box, 8 Module	8	198	20
	810867	Metal Flush Box, 9 Module	9	234	20
	800175	Metal Flush Box, 12 Module	12	258	10
	800179	Metal Flush Box, 16 Module	16	296	10
800180	Metal Flush Box, 18 Module	18	324	10	

WHITE SURFACE BOX • Flame Retardant Material • Edge to Edge Fitting with Plate

HSN Code: 8538

	Cat. Nos.	Description	Module	Unit Price (₹)	Pack
	800182	Plastic Surface Box, 1/2 Module	1/2	68	50
	800183	Plastic Surface Box, 3 Module	3	86	35
	800184	Plastic Surface Box, 4 Module	4	98	35
	800186	Plastic Surface Box, 6 Module	6	150	10
	800187	Plastic Surface Box, 8 Module (vertical)	8	204	15
	800188	Plastic Surface Box, 8 Module	8	204	10
	800185	Plastic Surface Box, 12 Module	12	256	10
	800189	Plastic Surface Box, 16 Module	16	298	10
	800190	Metal Surface Box, 18 Module	18	334	10

Cover Plates - ELVIRA
A SENSIBLE SWITCH

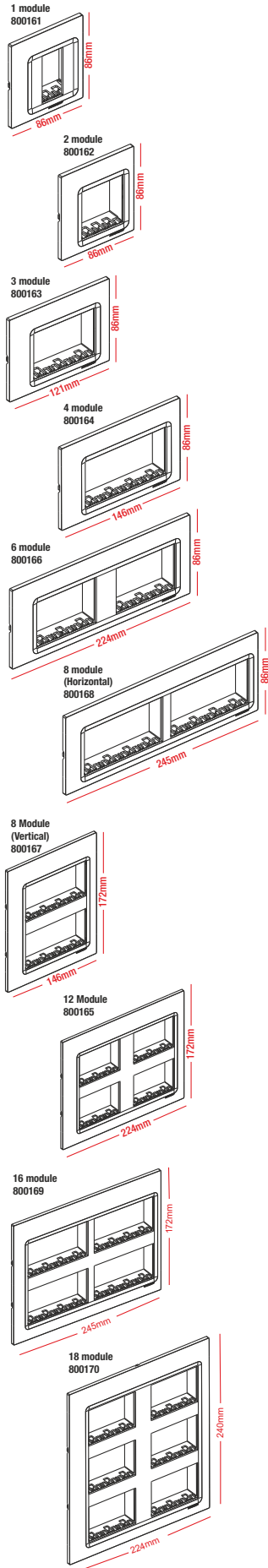

Flush Boxes-Metal

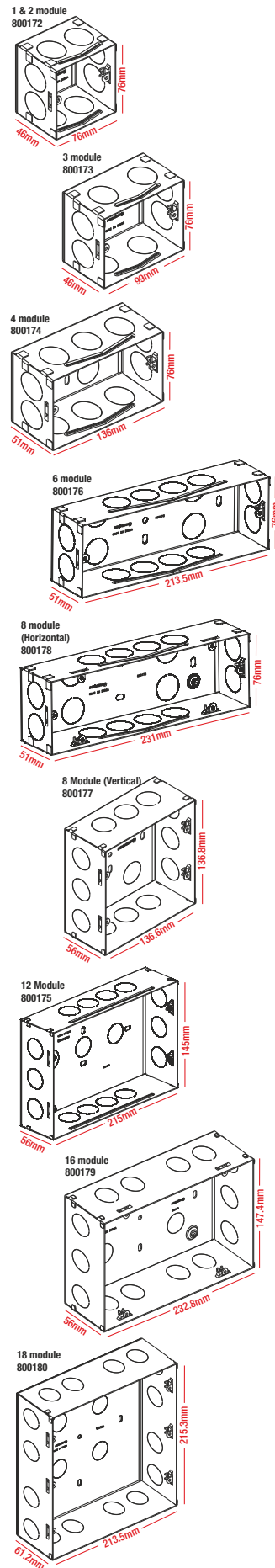

Surface Boxes-Plastic

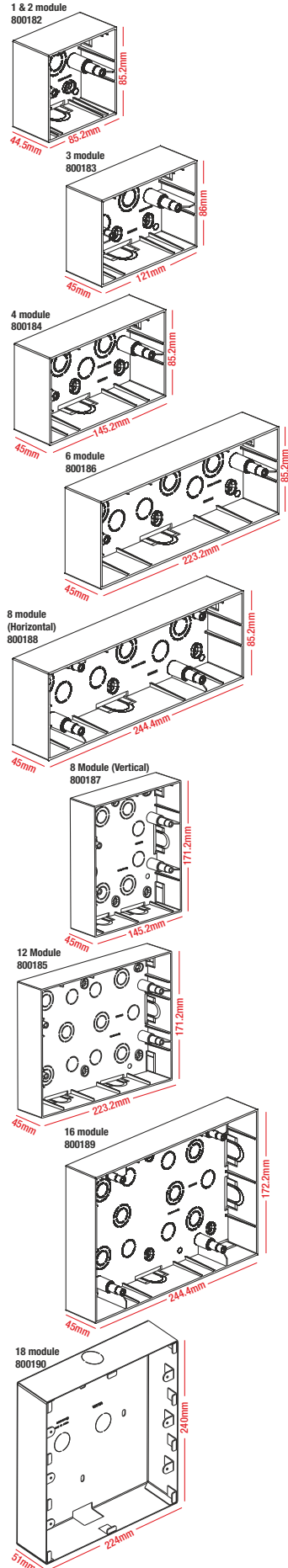

A POWERFUL EXHAUST FAN

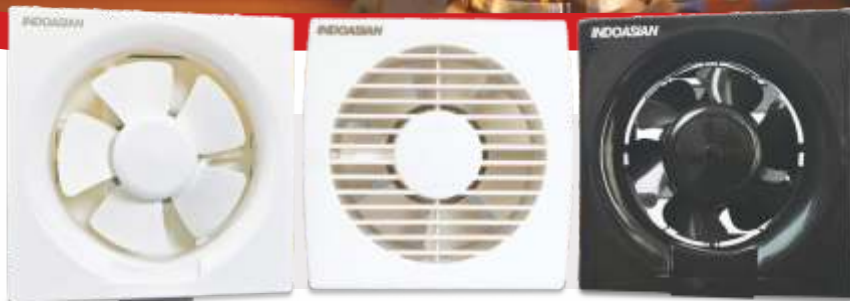

Zosta[™]

A RANGE TO MATCH YOUR NEEDS



LOW POWER
CONSUMPTION



EASY
INSTALLATION



ROHS
COMPLIANT

3 PIN PLUGS WITH EASY GRIP • White Matt Finish • Tested as per IS 1293

HSN Code: 8536

	Cat. Nos.	Description	Unit Price (₹)	Pack
	698470	6A 3 Pin Plug (ISI mark)	92	20/200
	698471	16A 3 Pin Plug (ISI mark)	136	10/100

FANCY BATTEN BULB HOLDER / CEILING ROSE • IS Standards • Dynamic Design

HSN Code: 8536

	Cat. Nos.	Description	Unit Price (₹)	Pack
	698473	Fancy Batten Bulb Holder White	80	20/200
	698474	Fancy Angle Bulb Holder White	80	20/200
	698475	Fancy Ceiling Rose White	52	20/200

EXHAUST FAN - WHITE / BLACK • Copper Motor • RoHS Compliant • Rust Free Body

HSN Code: 8536

	Cat. Nos.	Description	Unit Price (₹)	Pack
	698500	Exhaust Fan 150mm White	2080	1/6
	698501	Exhaust Fan 200mm White	2332	1/6
	698502	Exhaust Fan 250mm White	2664	1/6
	698503	Exhaust Fan 150mm Black	2080	1/6
	698504	Exhaust Fan 200mm Black	2332	1/6
	698505	Exhaust Fan 250mm Black	2664	1/6

AXIAL EXHAUST FAN - WHITE • Copper Motor • RoHS Compliant • Rust Free Body

HSN Code: 8536

	Cat. Nos.	Description	Unit Price (₹)	Pack
	698506	Axial Exhaust Fan 100mm White	1466	1/20
	698507	Axial Exhaust Fan 150mm White	1602	1/20

**BRIGHT IDEAS FOR HAPPY
& SAFE LIVING!**



BULB HOLDER & CEILING ROSE



Multiple Advantages



RoHS Compliant



Value For Money



Ducts For Heat
Dissipation



Long Lasting
Polycarbonate Plastic



Metal Ring
Avoid Deformation

GENERAL TERMS

- This price list supersedes all previous price lists.
- All prices are in Indian Rupees only.
- All prices are Maximum Retail Prices (MRP) inclusive of GST as applicable.
- Our discount structure is exclusive of GST
- Orders will be accepted in multiples of standard packing.
- Prices are subject to change without notice. All despatches will be as per prices prevailing on the date of despatch. Prices are ex-godown, exclusive of packing/forwarding/freight and insurance.
- Product design is subject to change without notice for continuous up gradation.
- Disputes if any are subject to Delhi Jurisdiction only.
- Company reserves the right to issue amendments which may arise due to any printing errors in the price list.

WARRANTY

IA products carry a warranty against manufacturing defects, subject to use of the product for the right application, with correct wiring/connection and normal operating conditions. Please refer to detailed IndoAsian warranty policy effective 1st Jan 2023.

MCBs	36 Months
RCCBs	36 Months
DBs/ACCL	12 Months
Rewirable/HRC Fuses	6 Months
MCCBs/BFF/Fuse Bases/Changeover Switchgears/SDF	12 Months
Time Switches	12 Months
For Wiring Devices - Switches & Socket	120 Months
For Wiring Devices - Electronic Products (e.g. Fan Regulator, Dimmer, Buzzer, RJ45, RJ11 & TV Sockets, Bell Indicator, Motor starter, Skirting light)	24 Months

CHANNEL PARTNER

CORPORATE OFFICE: V. J. Business Towers, A-6, 1st Floor, Sector-125, Noida-201301, U.P., India. Ph.: +91-0120-3305111 E-mail: customer.care@indoasian.com, international@indoasian.com Website: www.indoasian.com
CUSTOMER CARE HEAD: Novateur Electrical & Digital Systems Pvt. Ltd., V. J. Business Towers, A-6, 1st Floor, Sector-125, Noida-201301, U.P., India.
 Ph.: +91-0120-3305100 Toll Free no. 1800 103 7077 E-mail: customer.care@indoasian.com

NORTH

**Regional Sales office
DELHI NCR**
V. J. Business Towers
A-6, Ground Floor,
Sector-125, Noida-201303
Ph.: 0120-8858900

**Branch office
CHANDIGARH**
S.C.O.-11, 2nd Floor,
Sector-26, Madhya Marg,
Chandigarh-160002
Ph.: 0172-3934651

**Branch office
JAIPUR**
433, 4th Floor, Ganpati Plaza,
M. I. Road,
Jaipur-302001
Ph.: 0141-4113528

**Branch office
LUCKNOW**
301, 3rd Floor, Chintel House,
Station Road,
Lucknow-226001
Ph.: 0522-4013210

SOUTH

**Regional Sales office
BANGALORE**
787, 1st Floor "Skyline Vista"
15th Cross, 100 Feet Ring Road
J P Nagar 1st Phase
Bangalore-560 078
Tel: 080-46219999

**Branch office
COCHIN**
Door No.65/1317, Syda Building,
2nd Floor, Kaloor-Kadavanthra Road,
Kaloor, Ernakulam District,
Kochi-682017 (Kerala)
Ph.: 0484-405581-88

**Branch office
COIMBATORE**
Door No. 83,
Dr. Nanjappa Road,
Coimbatore-641018
Ph.: 0422-2302715

**Branch office
CHENNAI**
No.5, 1st Floor, Mahalingapuram Main Road,
Nungambakkam,
Chennai-600034
Ph.: 044-28172096, 28170527

**Branch office
HYDERABAD**
312, 3rd Floor,
Amrutha Estates, Himayath Nagar,
Hyderabad-500029
Ph.: 040-66742425

WEST

**Regional Sales office
MUMBAI**
401 & 408, K.P. Arrum,
Marol Morshi Road, Andheri East,
Mumbai-400059
Ph.: 022-61035800

**Branch office
AHMEDABAD**
102, 1st Floor, Shivalik High Street,
Near Mansi Circle, Vastrapur,
Ahmedabad-380015
Ph.: 079-29701351-53

**Branch office
INDORE**
Tower B, 403 - The One
Ravindra Nath Tagore Marg,
Indore- 452001
Ph.: 0731-4677510

**Branch office
PUNE**
311, Pride Silicon Plaza,
Bhamburda, Shivaji Nagar,
Senapati Bapat Marg,
Pune-411016
Ph.: 8087610722

EAST

**Regional Sales office
KOLKATA**
"Raikva Building" Room No. 8, 2nd Floor,
3A Ram Mohan Garden Lane,
Beliaghata E.M.Bypass, Kolkata-700010
Ph.: 033-66041503

IA/Price List/05-23/8/000

INDOASIAN
MAKES SENSE

WESUPPORT

E-mail: customer.care@indoasian.com

INDOASIAN
MAKES SENSE